

SMITHCO

Wayne, Pennsylvania 19087

**OPERATOR'S
MANUAL**

SPRAY STAR 1600P

Model 1610P

November, 1999

Revised 2-8-02

SMITHCO PRODUCT SUPPORT

1-800-891-9435

Hwy SS and Poplar Avenue, Cameron WI 54822

E-mail: productsupport@smithco.

CONTENTS

Introduction	1-10
Introduction	1
Symbols	2-3
General Safe Practices	4
Safe Spraying Practices	5
Specifications	6
Optional Spray Equipment	6
Set Up	7-8
Controls & Instruments	9-10
Operation	11-17
Schematics	18-19
Hydraulic Schematic	18
Wiring Schematic	19
Spraying Procedure	20-26
Spraying Introduction	20
Turf Management	20
Hose & Handgun Spraying	21
Nozzles	21-22
Calibration Introduction	23
The Nozzle Chart Method of Calibration	24-25
The “128” Method of Boom Sprayer Calibration	25-26
Nozzle Charts	28-33
Nozzle Performance Chart #1	28
Nozzle Performance Chart #2	29
Nozzle Performance Chart #3	30
Nozzle Performance Chart #4	31
Nozzle Performance Chart #5	32
Nozzle Performance Chart #6	33
Reference	34-35
Abbreviations and Conversions	34
Declaration of Conformity	35
Limited Warranty	Inside Back Cover

Thank you for purchasing a **SMITHCO** product.

Read this manual and all other manuals pertaining to the Spray Star carefully as they have safety, operating, assembly and maintenance instructions. Failure to do so could result in personal injury or equipment damage. Keep manuals in a safe place after operator and maintenance personnel have read them. Right and left sides are from the operator's seat, facing forward.

All **SMITHCO** machines have a Serial Number and Model Number. Both numbers are needed when ordering parts. The serial number plate on the Spray Star is located on the front left side of the main frame. Refer to engine manual for placement of engine serial number.

For easy access record your Serial and Model numbers here.

SMITHCO		DATE OF MFG.
WAYNE, PENNSYLVANIA 19087 USA 610-688-4009 Fax 610-688-6069		<input type="text"/>
SERIAL NO.	kW/hp	
<input type="text"/>	<input type="text"/>	
MODEL NO.	kg/lb	
<input type="text"/>	<input type="text"/>	



Information needed when ordering replacement parts:

1. Model Number of machine.
2. Serial Number of machine.
3. Name and Part Number of part.
4. Quantity of parts.

SYMBOLS



Read Operator's Manual



Electrical Power



No Electrical Power



Engine - Stop



Engine - Start



Engine - Run

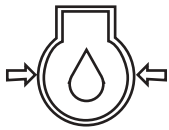

Engine Oil



Temperature Light

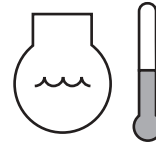

Water Temperature

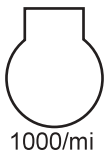

RPM

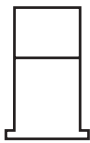

Gasoline



Diesel



Glow Plug - On



Glow Plug - Off



Glow Plug



Hour Meter

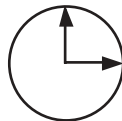

Hour Meter

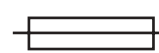

Fuse



Hand Throttle



Choke - Closed



Choke - Open









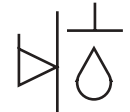



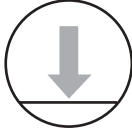

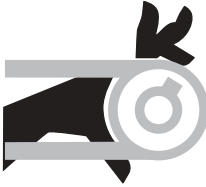

Park Brake

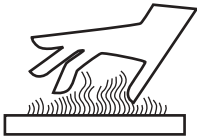
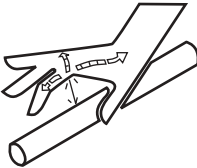
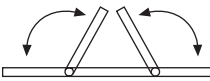
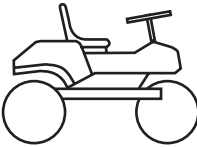

Park Brake Release

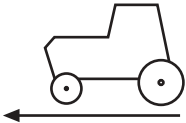

Hydraulic Oil Level

	Up/Down Arrow		Down/Lower		Up/Raise
	No Smoking		Moving Parts		Manual Operation
	Pinch Point		Step		Hot Surface
	Hydraulic Fluid Penetration		Lift Arm		Tractor
	Engage		Disengage		PTO
	Ground Speed		Fast		Slow
H	High	L	Low	F	Forward
R	Reverse	N	Neutral		Warning Danger Caution

SAFE PRACTICES

1. It is your responsibility to read this manual and all publications associated with this machine.
2. Never allow anyone to operate or service the machine or its optional equipment without proper training and instructions. Never allow minors to operate any equipment.
3. Learn the proper use of the machine, the location and purpose of all the controls and gauges before you operate the equipment. Working with unfamiliar equipment can lead to accidents.
4. Wear all the necessary protective clothing and personal safety devices to protect your head, eyes, ears, hands and feet. Operate the machine only in daylight or in good artificial light.
5. Inspect the area where the equipment will be used. Pick up all debris you can find before operating. Beware of overhead obstructions and underground obstacles. Stay alert for hidden hazards.
6. Never operate equipment that is not in perfect working order or without decals, guards, shields, or other protective devices in place.
7. Never disconnect or bypass any switch.
8. Carbon monoxide in the exhaust fumes can be fatal when inhaled, never operate a machine without proper ventilation.
9. Fuel is highly flammable, handle with care.
10. Keep engine clean. Allow the engine to cool before storing and always remove the ignition key.
11. Disengage all drives and set park brake before starting the engine.
12. Never use your hands to search for oil leaks. Hydraulic fluid under pressure can penetrate the skin and cause serious injury.
13. This machine demands your attention. To prevent loss of control or tipping of the vehicle:
 - A. Use extra caution in backing up the vehicle. Ensure area is clear.
 - B. Do not stop or start suddenly on any slope.
 - C. Reduce speed on slopes and in sharp turns. Use caution when changing directions on slopes.
 - D. Stay alert for holes in the terrain and other hidden hazards.
14. Before leaving operator's position:
 - A. Disengage all drives.
 - B. Set park brake.
 - C. Shut engine off and remove the ignition key.
 - D. If engine has to run to perform any maintenance keep hands, feet, clothing and all other parts of body away from moving parts.
15. Keep hands, feet and clothing away from moving parts. Wait for all movement to stop before you clean, adjust or service the machine.
16. Keep the area of operation clear of all bystanders.
17. Never carry passengers.
18. Stop engine before making repairs/adjustments or checking/adding oil to the crankcase.
19. Use parts and materials supplied by **SMITHCO** only. Do not modify any function or part.
20. Use caution when booms are down as they extend out beyond the center line of the machine.
21. The tank is a confined space, take precaution.

This machine is intended for turf maintenance. Other use is forbidden.



Persons engaged in the handling, preparation or application of chemicals must follow accepted practices to insure the safety of themselves and others,

1. **WEAR** protective clothing including: gloves, hat, respirator, eye protection and skin covering suitable for protection from chemicals being used.
2. **BATHE** thoroughly after any exposure to chemicals, giving particular attention to eyes, nose, ears and mouth.
3. **CLEAN** equipment and materials in accordance with employer, municipal and state regulations. Use only approved areas and drains.
4. **DISPOSE** of chemicals and rinse solutions by approved and legal means.
5. **PROVIDE** methods and materials for operators to wash eyes and hands immediately during the spraying process.
6. **PROVIDE** methods and materials for control, safe dilution and neutralization of chemical spills during preparation, spraying, transporting and cleanup.
7. Always check and follow the directions and safety warnings of the chemicals to be used.
8. Secure the discharge lines before starting the pump. An unsecured discharge line may whip.
9. Periodically inspect the pump and the system components.
10. Check hoses for weak or worn condition before each use. Make certain that all connections are tight and secure.
11. Do not operate unit with leaks, frayed, kinked hoses or tubing. Repair or replace immediately.
12. Use only pipe, hose and fittings rated for maximum pressure or pressure at which pressure relief valve is set at. When replacing pipe, hose or fittings, use new product.
13. Do not operate a gasoline engine in an enclosed area. Be sure the area is well ventilated.
14. Do not use these pumps for pumping water or other liquids for human or animal consumption.
15.  **Do not pump flammable or explosive fluids such as gasoline, fuel oil, kerosene, etc. Do not use in explosive atmospheres. The pump should be used only with liquids compatible with the pump component materials.**
WARNING
16. Be sure all exposed moving parts are guarded and that all coupling devices are securely attached before applying power.
17. Before servicing, disconnect all power, make sure all pressure in the system is relieved, drain all liquids from the system and flush.
18. Protect pump from freezing conditions by draining liquid and pumping rust inhibiting antifreeze solution through the system, coating the pump interior.

SPECIFICATIONS

WEIGHTS AND DIMENSIONS

Length	112" (285 cm)	
Width	61" (155 cm)	Width With Booms Down 230" (584 cm)
Height	50" (127 cm)	Height With Booms Up 126" (320 cm)
Wheel Base	60" (152 cm)	
Weight Empty	1200 lb (544 kg)	Weight Loaded 2500 lb (1134 kg)

SOUND LEVEL AT 3400 RPM

At ear level	84 dB
At 3 ft. (0.914 m)	82 dB
At 30 ft (9.14 m)	68 dB
At 23 ft (7 m) pass by	70 dB

ENGINE

Make	Kohler
Model#	Command CH20S
Type / Spec#	64558
Horsepower	20 hp (15 kW)
Fuel	Unleaded 87 Octane Gasoline Minimum
Cooling System	Air cooled
Lubrication System	Full pressure
Alternator	25 Amp

WHEELS & TIRE

Front (2) 20 x 1000 x 10 Multi-rib 20 psi (1.4 bar)
 Rear (2) 24 x 1300 x 12 Super Soft 18 psi (1.3 bar)
 Ground Pressure: 8.2 psi with 160 gallons

SPEED

Working Speed	1st gear 0-3 m.p.h. (0-5 kph) 2nd gear 2-6 m.p.h. (3-10 kph)
Transport Speed	3rd gear 4-10 m.p.h. (6-16 kph)
Reverse Speed	0-3 m.p.h. (0-5 kph)

BATTERY

	Automotive type 24F-12 volt
BCI Group	Size 24
Cold Cranking Amps	575 minimum
Ground Terminal Polarity	Negative (-)
Maximum Length	10.25" (26 cm)
Maximum Width	6.88" (17 cm)
Maximum Height	10" (25 cm)

FLUID CAPACITY

Crankcase Oil	2.1 quart (2 liters) with filter
Fuel	8 gallon (30.25 liters)
Hydraulic Fluid	1 gallon (3.785 liters)
Grade of Fluid	SAE 10W-40 API Service SJ or higher motor oil

OPTIONAL SPRAY EQUIPMENT

14-100	Super Boom 20' (6 meter) Long	10-300	18' Terrain Following Boom
15-363	Fresh Water Wash Tank	10-301	15' Terrain Following Boom
15-425	Hose Reel Mounting Frame	15-493	Auto-Boom 18' (5.5 m) Long
15-571	15' Tri-Section Electric Lift Star Shield Boom	14-301	440 Spray System (1602P)
15-572	15' Dual Section Electric Lift Star Shield Boom	14-302	203 Spray System (1604P)
15-573	15' Manual Lift Star Shield Boom	14-303	Manual Spray System (1610P)
16-856	Tank Rinsing System	14-304	844 Spray System (1607P)
16-129	Hose Reel 200' (61 m) capacity (to be used with 15-425)	15-499	Foam Marker System (Dealer Installed)
16-906	Hose Reel 12 volt electric rewind 200' (61 m) capacity (to be used with 15-425)	15-501	Foam Marker System (Factory Installed)



The Model 1600P Prime Mover arrives from **SMITHCO** setup and ready for service. Depending on freight conditions the tires, wheels and steering wheel may need to be installed.

The spray system is normally shipped attached to the 1600P Prime Mover. If a spray system is to be retrofitted to a 1600P Prime Mover by a dealer or owner, assemble and attach the components in accordance with the parts drawings in the *Spray Star 1600P Parts/Service Manual*.

1. Remove the top and sides from the shipping crate then remove the banding from the Spray Star.



Banding is under tension.

2. Lift front end using a hydraulic jack, taking care that the jack is not placed in a location that would damage any steering system components, install front wheels and torque nuts to 64-74 ft/lb (87-100 Nm). Then raise rear axle using a hydraulic jack and install rear wheels and tires, torque lug nuts to 64-74 ft/lb (87-100 Nm). Torque again after the first 10 hours and every 200 hours thereafter.
3. Set park brake.
4. Check the tire pressure. The front tires are 20 psi (1.4 bar) and the rear tires are 18 psi (1.3 bar).
5. Remove the tape holding woodruff key (Ref B) to the shaft. Put steering wheel (Ref A) on the shaft of the steering mechanism (Ref C). Tighten nut to 30-40 ft/lb (41 - 54 Nm). **Do not over tighten.**

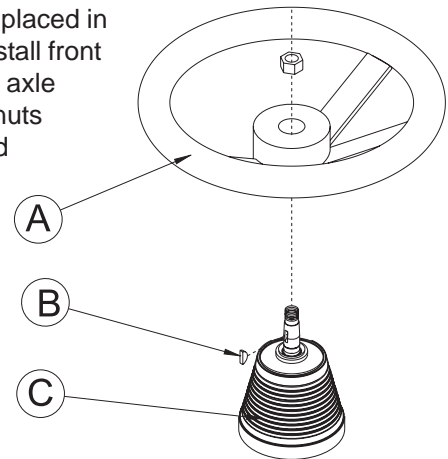

6. Install the seat with the stud going through the engine cover and the flat washers, lock washers and nuts. Use the front set of holes for shorter drivers and use the back set of holes for taller drivers.
7. Be sure battery (automotive type 24F-12 volt; 575 cold cranking AMPS minimum; 10.25" (260 mm) long x 6.88" (175 mm) wide x 10" (254 mm) high maximum case) is installed in proper position in the battery box, which is located on the left side of the engine compartment. Battery posts should be to the rear. This is a negative grounding system.



Connecting battery cables to the wrong post could result in personal injury and/or damage to the electrical system. Make sure battery and cables do not interfere or rub on any moving part. Connect red positive (+) cable (A) to battery first. When disconnecting remove black negative (-) cable (B) first.

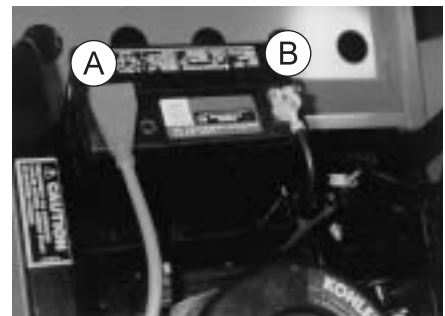

8. Check the engine oil and add as necessary. The dip stick is located in cutout hole behind the seat on the left side. Oil fill is located on top of valve cover, use SAE 10W-40 API Service SJ or higher motor oil. **DO NOT OVERFILL.**
9. Fill fuel tank, located on right side, with Unleaded 87 Octane gasoline (minimum).



Gasoline is flammable, caution must be used when storing or handling it. Do not fill fuel tank while engine is running or in an enclosed area, fumes are explosive and dangerous to inhale. DO NOT SMOKE while filling the fuel tank. DO NOT OVERFILL.

SET UP (CONTINUED)

10. Check brake fluid in master cylinder by removing round plug on floorboard. Add brake fluid if necessary. DOT 3.
11. Check hydraulic fluid. The hydraulic power unit is located between the engine and the spray tank on the left hand side. Remove breather plug and add SAE 10W-40 API Service SJ or higher motor oil if necessary. Fluid level should be about 1.5" (38 mm) below top of tank when cold.
12. Check the transmission fill plug on the right hand side of the transmission and check the rear axle fill plug located on the back side. They should be filled with SAE 80W-90 Gear Lube API Service GL-5, GL-4 so that the level is even or a little below the bottom of the fill hole.
13. Machine should be greased before starting, refer to *Spray Star 1600P Parts/Service Manual* for location.
14. Attach the Spray Boom and any other Optional Equipment to the Prime Mover, in accordance with instructions in the *Spray Star 1600P Parts/Service Manual*. The nozzles must be the correct distance above the turf as described in *Spraying Procedure* of this manual. The spray boom must operate properly and the outer sections must break away safely if an object is struck by them, they must then return to normal operation position.
15. Be sure to double check boom heights, nozzle spacing and displacement before spraying.
16. Fill tank with water and retighten the four bolts used to hold the tank in place.
17. Read operating instructions before starting.

NOTE: Never allow pump to run dry! The valve on the suction side of the pump (between the pump and tank) must be fully open whenever the pump is operated.

DAILY CHECKLIST

1. Check park brake adjustment. Adjust as required.
2. Check engine oil level. Add as needed. DO NOT OVERFILL.
3. Tire pressure should be 20 psi (1.4 bar) front and 18 psi (1.3 bar) rear maximum.
4. Inspect electrical system for loose connections or frayed wiring, including battery cables. Replace any faulty equipment or tighten if loose.
5. Check hardware for loose or missing nuts, bolts, screws, etc., and tighten or replace as needed.
6. Inspect hydraulic lines for damage or leaks. Never use hands to inspect leaks.
7. Check brake fluid in master cylinder by removing round plug on floorboard. Add DOT 3 brake fluid if necessary.
8. Check hydraulic fluid. The hydraulic power unit is located between the engine and the spray tank on the left side. Remove breather plug and add SAE 10W-40 API Service SJ or higher motor oil if necessary. Fluid level should be about 1.5" (4 cm) below top of tank when cold.
9. Check the transmission fill plug on the right side of the transmission and check the rear axle fill plug located on the back side. They should be filled with SAE 80W-90 Gear Lube API Service GL-5, GL-4 so that the level is even or a little below the bottom of the fill hole.
10. Inspect steering, throttle and shift linkages for good hookups and clear travel.
11. Check anti-vibration mounts on engine frame.
12. Check controls for smooth, proper working operation. Lubricate as needed.

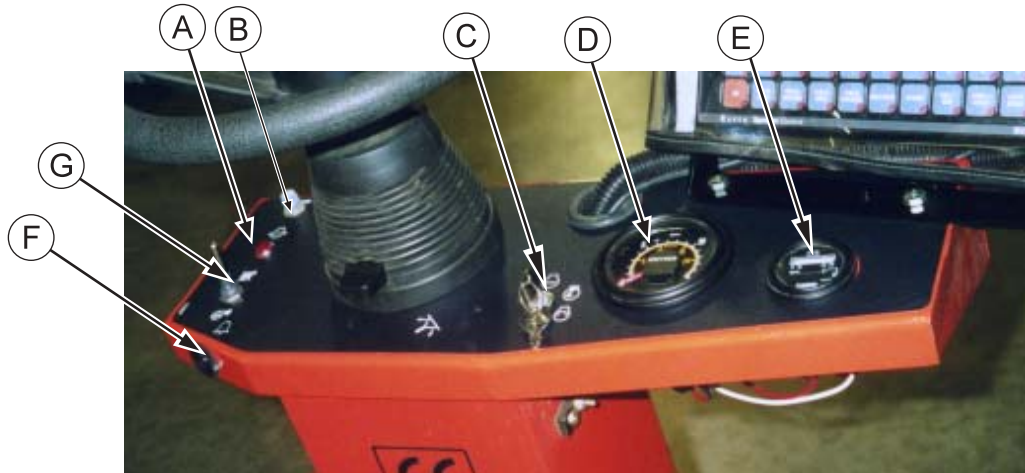

- A. Oil Light:** The Oil Light should come on when the ignition is on, without the engine running and should go out when the engine is running. The Oil Light will light when the oil pressure is low. If it does come on, shut off the engine and find the cause immediately.
- B. Circuit Breaker:** The circuit breaker is a resetable fuse. To reset push down.
- C. Ignition Switch:** The ignition switch has three positions: Off-Run-Start.
- D. Speedometer:** The speedometer indicates ground speed of vehicle in miles per hour and kilometer per hour.
- E. Hour/Volt Meter:** The hour meter indicates the hours of machine operation. The hour meter operates when the ignition switch is on. The volt meter indicates battery voltage. When starting, the battery voltage should not drop below 9 volts. With key on, engine running, the voltage should be 12 volts. With engine running at 3600 rpm the voltage should read about 14 volts.
- F. Buzzer:** The buzzer sounds if the pump is running dry.
- G. Pump On/Off Switch:** Turns pump on and off.
- H. Clutch Pedal:** Located to the left side on the floorboard. Must be pressed down to disengage the clutch and activate the interlock switch.
- I. Brake Pedal:** Located in the middle of the floorboard. Operates the hydraulic brakes on the rear axle.
- J. Accelerator Pedal:** Located on the right side of floor board. This pedal controls ground speed. Press pedal to increase engine RPM, varying the amount of movement of the pedal will vary the ground speed.

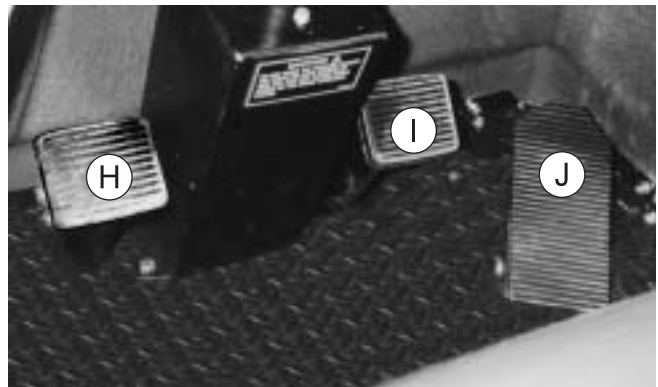

SEAT ADJUSTMENT

Adjustment lever is located under the front of the seat on the right side. It allows the seat to be adjusted forward or backwards for the operator's comfort. For further adjustment unbolt seat from seat panel, move to other set of holes and re-bolt.

STEERING

Hydraulic steering. Before operating acquaint yourself with the steering.



Avoid sharp turns at high speeds, on slopes or unsafe terrain.

CONTROLS & INSTRUMENTS (CONTINUED)

CONTROL PANEL

Located on right side of seat. The following are located on or near the control panel.

- A. **Choke:** Pull out choke when starting cold engine, push in when engine starts.
- B. **Ground Speed:** The Ground speed control is a device that limits the accelerator movement at the engine. Its purpose is to provide the operator with the ability to maintain a constant ground speed (predetermined) by the full depression of the accelerator pedal.
- C. **Shift Lever:** Gear selection, with the shift pattern on the shift knob.
- D. **Hand Throttle:** This hand throttle is used for hose/handgun spraying, boom spraying and sprayer calibration. It controls engine RPM, forward for fast, opposite direction for slow. (Not to be used when in motion).
- E. **Right and Left Boom Switches:** These toggle switches are used to raise and lower the right and left electric actuated booms.

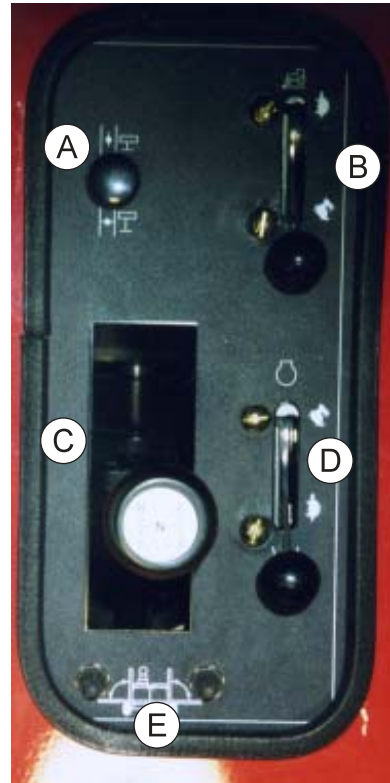

FOAM MARKER CONTROLS

- F. **Park Brake:** Push to the front and down to set park brake and pull back to release. Some adjustments can be made to park brake by turning knob on the of the lever. To tighten, turn knob clockwise. To loosen turn counter clockwise.
- G. **Foamer ON/OFF Switch:** Located to the right of the control panel. Used to turn on and off the foam marker. Also, used to designate which boom is to be used to dispense foam. With lever pointing toward the seat foam will dispense from right boom, and with lever pointing forward foam will dispense from the left boom.
- H. **Foamer Adjustment Knob:** Located behind the seat on the right side on top of the foamer. Use this knob to adjust pressure of the foam that will be dispensed.

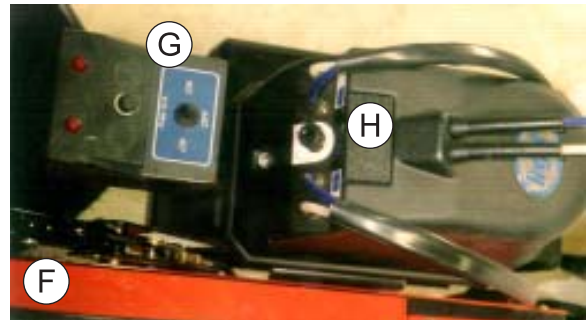

Before operating the Spray Star 1600P, become familiar with all controls and functions. Also complete all maintenance requirements and read all safety warnings. Knowing the Spray Star 1600P thoroughly, how it operates, and by doing the prescribed maintenance steps, you can expect trouble free operation for years to come.

SAFETY

Safety needs to always be the concern of an operator of a moving vehicle or any machine with moving parts.

1. Keep all shields and guards in place.
2. Keep the parking brake engaged any time the operator is away from the vehicle or whenever service is performed.
3. Always wear the necessary protective clothing and equipment.
4. Turn engine off when refueling or performing maintenance not specifically requiring engine power.

STARTING THE ENGINE

1. Make sure the fuel flow valve is 'On'. It is located on the fuel tank.
2. Make sure the spray pump is disengaged.
3. Depress the clutch pedal to activate the interlock switch.
4. Place shift lever in neutral.
5. The ignition switch is located to the right of the steering column. Insert the key (A) and turn clockwise until the engine starts (C). Release the key and it will return to the run position (B). Use the choke and hand throttle as necessary.
6. Allow engine to idle and warm up before selecting direction of travel.
7. Make sure the park brake is disengaged.

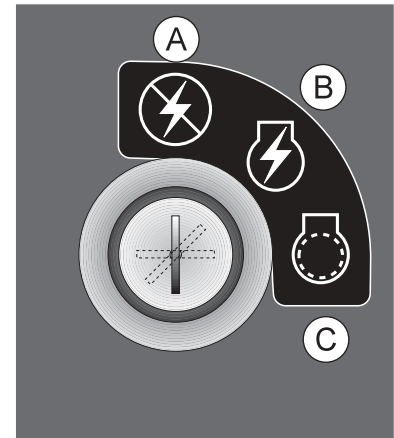

STOPPING THE ENGINE

NOTE: If the engine has been running under high power, let it run at slow idle speed a few minutes to cool the engine down, before turning the ignition switch to the OFF position.

1. Disengage spray pump.
2. Move the throttle lever to "slow" and turn ignition key to the "off" position.
3. Remove the ignition key and engage the park brake.



Never leave the vehicle unattended with the engine running. Always bring the vehicle to a complete stop, engage park brake, turn key off and remove key.

OPERATING INSTRUCTIONS (CONTINUED)

Before using the Spray Star 1600P, the operator and spray technician must familiarize themselves with all of the information on chemical spraying contained in the *Turf Spray Guide*.

NOTE:

All testing and calibration of sprayers is to be done with water, not chemicals. This insures the safety to all involved in performing the calibration operation. Only after all calibration procedures are completed should chemical be added to the sprayer.

OPERATION OF THE 3-SPEED TRANSMISSION

The transmission provides 3 forward speeds and reverse. The operator selects the speed (gear) in which he or she wishes to operate depending on the ground speed desired. The Spray Star can be started and operated in any speed. It is not necessary to start in low gear.

GEAR	RATIO	USE	SPEED RANGE
1st	2.60:1	Spraying	0-3 m.p.h. (0-5 kph)
2nd	1.63:1	Spraying	2-6 m.p.h. (3-10 kph)
3rd	1.00:1	Transporting	4-10 m.p.h. (6-16 kph)
Reverse	3.54:1	Reverse	0-3 m.p.h. (0-5 kph)

Select the gear desired by moving the shift lever located at the operator's right side to the point indicated by the shift pattern found on the shift knob.

Spraying should be done in the lowest gear possible that will provide the desired ground speed. This will maximize pump performance and minimize ground speed variance due to uneven terrain.

GROUND SPEED CONTROL

1. Select the gear to be used.
2. Place the Ground Speed Control lever at "10".
3. Start the vehicle and engage the clutch to begin moving.
4. Push the foot accelerator fully to the floor.
5. While the foot accelerator is fully depressed, begin moving the Ground Speed Control lever towards "0" until the correct operating speed is attained.
6. The desired speed will be maintained as long as the foot accelerator is fully depressed.
7. Vehicle will return to the established ground speed whenever the foot accelerator is fully depressed unless the Ground Speed Control lever has been moved to a different setting.
8. To operate the Spray Star at higher speed for transport, the Ground Speed Control lever should be returned to the "10" position.

HAND THROTTLE CONTROL LEVER

Transmission must be in neutral and park brake set when engine throttle control is used.

To increase the engine speed without holding your foot pedal down, use the engine throttle control lever on the right hand control panel. Push the lever forward until the desired rpm is attained.

This procedure will set the RPM allowing the operator to use the remote hose and handgun. It will also permit the operator to check the operation of the spray boom by observing it from the rear of the vehicle.

To release throttle control, pull back on the Lever allowing the engine to return to idle.

Transmission must be in neutral and parking brake set when engine throttle control is in use.



Never drive vehicle with engine speed increased by engine throttle lever. Loss of vehicle control may result.

OPERATING INSTRUCTIONS (CONTINUED)

TOWING UNIT

When it is necessary to move the Spray Star 1000 without the engine running, the by-pass valve built into hydrostatic pump must be "open" by turning it counter-clockwise. The valve is located on the bottom of the pump. An "open" valve allows fluid to pass through the wheels freely. When normal driven operation is desired, valve should be "closed" by turning it clockwise. Failure to "close" the valve with engine running means no power to wheels.

HILLSIDE OPERATION

Do NOT stop or start suddenly on any slope. Be especially cautious when changing direction. Do NOT operate on slopes greater than 20°.

BATTERY

Batteries normally produce explosive gases which can cause personal injury. Do not allow flames, sparks or any ignited object to come near the battery. When charging or working near battery, always shield your eyes and always provide proper ventilation.

Battery cable should be disconnected before using "Fast Charge".

Charge battery at 15 amps for 10 minutes or 7 amps for 30 minutes. Do not exceed the recommended charging rate. If electrolyte starts boiling over, decrease charging.

Always remove grounded (-) battery clamp first and replace it last. Avoid hazards by:

1. Filling batteries in well-ventilated areas.
2. Wear eye protection and rubber gloves.
3. Avoid breathing fumes when electrolyte is added.
4. Avoid spilling or dripping electrolyte.



Battery Electrolyte is an acidic solution and should be handled with care. If electrolyte is splashed on any part of your body, flush all contact areas immediately with liberal amounts of water. Get medical attention immediately.

JUMP STARTING



Use of booster battery and jumper cables. Particular care should be used when connecting a booster battery. Use proper polarity in order to prevent sparks.

To jump start (negative grounded battery):

1. Shield eyes.
2. Connect ends of one cable to positive (+) terminals of each battery, first (A) then (B).
3. Connect one end of other cable to negative (-) terminal of "good" battery (C).
4. Connect other end of cable (D) to engine block on unit being started (NOT to negative (-) terminal of battery)

To prevent damage to other electrical components on unit being started, make certain that engine is at idle speed before disconnecting jumper cables.

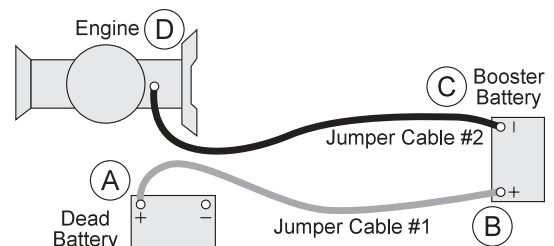

OPERATING INSTRUCTIONS (CONTINUED)

MAIN CONTROL VALVEE

Front View

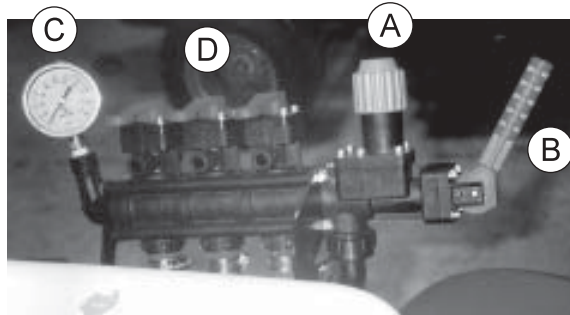

Back View

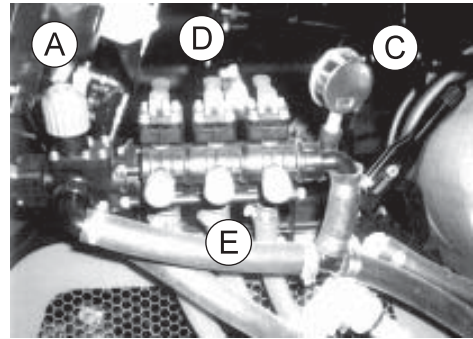

- A.
- A. Main Pressure Adjustment - Turn to adjust desired pressure on the pressure gauge.
 - B. Main Boom Lever - Allows pressure to enter the system. Down is engage, up is disengage.
 - C. Pressure Gauge - indicates in PSI when spraying.
 - D. Boom Levers - Three levers that turn on each boom section, right - center - left.
 - E. Boom Pressure Adjustment - Three adjustment knobs that adjust the pressure for each boom. They match the boom lever that is above them. To raise pressure close knob. To lower pressure open knob.

SPRAYER VALVE SETTING

1. Engage the main boom lever(B) to allow pressure into the system.
2. Flip all boom levers(D) up to engage.
3. Adjust the main pressure(A) to show desired pressure on pressure gauge(C).
4. Doing one boom section at a time, Push the first boom lever(D) down or shut off. If pressure gauge drops in psi close the boom pressure knob(E) below boom lever. If pressure rises open boom pressure knob. Objective is to have equalized pressure when the boom lever is flipped. Do this with all three boom levers.
5. When pressure is equalized an all three booms the valve has been configured for spraying.

OPERATING INSTRUCTIONS (CONTINUED)

SPRAYER VALVE SETTINGS AND SPRAY TANK AGITATION

The gate valve on the suction side of the pump, between the tank and the pump must be open before pump is engaged. Close this valve only when necessary to clean the filter with spray material in the spray tank.

There are three manual flow control valves on the discharge side of the spray system.

The agitator ball valve (A) controls the agitator. This valve may be opened as much as necessary to provide hydraulic agitation through the quadrajet agitator in the tank bottom. This valve may be partially closed to prevent or reduce foam buildup from the spray materials inside the tank. When the liquid level in the spray tank reaches a certain level (usually 1-25 gallons (3.8-95 Liters) depending on terrain and other conditions) it may be necessary to close the valve in the agitator line in order to prevent loss of suction prime.

The main control valve (B) controls the spraying. This larger flow control valve is used to set the general pressure range at which the system will operate. Partially close the valve to increase pressure, open the valve to decrease pressure. Also close this valve before cleaning filter if there is liquid in the tank. This valve controls flow to all three boom sections. With the Manual System all three boom sections operate together.

The throttling ball valve (C) controls the pressure going to the solenoid valve.

If your Spray Star is fitted with a hose reel, there is a fourth ball valve on the discharge system to supply material to the hose reel.

The Quadrajet agitation system operates with four venturi jets in the tank bottom. These jets have replaceable orifice discs which discharge the following amounts of spray material.

Nozzle Diameter	Input to Agitator in gpm	Input to Agitator in L/min	Agitator Pressure in psi	Agitator Pressure in bar	Agitator Output in gpm	Agitator Output in L/min
1/8"	1.9	7.2	25	1.7	6.3	23.8
1/8"	2.7	10.2	50	3.4	10.0	37.9
1/8"	3.8	14.4	100	6.9	15.0	56.8
5/32"	2.8	10.6	25	1.7	7.6	28.8
5/32"	4.2	15.9	50	3.4	12.2	46.2
5/32"	5.5	20.8	100	6.9	17.5	66.2
3/16"	3.6	13.6	25	1.7	9.1	34.4
3/16"	5.6	21.2	50	3.4	14.3	54.1
3/16"	7.9	29.9	100	6.9	18.7	70.8

You can change orifice disc sizes to enhance spray system performance. Smaller discs reduce amount of agitation (desirable in some foaming materials) and make more dischargeable liquid available for nozzles. Larger (or none) discs increase amount of agitation and make less dischargeable liquid available for nozzles.

INITIAL SYSTEM SET-UP

1. Fill tank with water only.
2. Place Master On/Off switch to On, Boom On/Off switches to Off, and open tank shut-off valves.
3. With Pump **not running**, fully open main line hand valve and totally close agitator line hand valve.
4. Verify that each boom solenoid valve operates by operating Boom On/Off switches and that no nozzles are plugged.
5. Place all Boom On/Off switches On.
6. Hold the Pressure Adjust switch in the increase position until the pressure stops increasing and begins to decrease.
7. Adjust agitator line hand valve for desired agitation.
8. Close the main line hand valve, if necessary, to set the maximum desired operating pressure. (The maximum pressure should be approximately 10 psi (69 kPA), above the normal spraying pressure.)
9. Hold the Pressure Adjust switch in the decrease position until the pressure stops decreasing and begins to increase. If desired minimum pressure cannot be obtained, install larger bypass hose.
10. Verify the desired maximum pressure of the sprayer system by repeating step 6.

SPRAY OPERATION (After Proper Setup and Calibration)

1. Add 1/2 the amount of water required for the spray operation to tank using air gap filler.
2. Start engine, set engine speed below 2000 RPM, and engage pump after taking all previously described safety and operation precautions.
3. Open agitator valve.
4. Add chemicals (taking all precautions described in this manual and by the chemical manufacturer).
 - a. Liquids may be poured directly into tank.
 - b. Wettable powder chemicals must be pre-mixed with water in a container to form a slurry. The mixture is then added to the tank through the fillwell strainer.
 - c. Chemical in soluble packs are place into the fillwell strainer basket and dissolved by adding water through the basket.

The balance of the water required for the spray operation is added to the tank through the fillwell strainer, using the air gap filler. This will wash any undissolved chemical into the tank.

5. Transport to sprayer site with and agitator operating.
6. Set Engine speed between 2000-3200 RPM.
7. (Optional) Engage ground speed control.
8. Obtain desired spraying speed before activating spray with switches on spray control console.



CAUTION

Review the capacity of nozzles being used. Total capacity of all nozzles plus agitation system must not exceed pumping system capabilities refer to *Spraying Procedure* section of this manual. FLUSH PUMP AFTER USE

Shut-Off	20GPM	40GPM	60GPM	80GPM	100GPM
120psi	100psi	80psi	60psi	30psi	10psi
100psi	95psi	76psi	52psi	26psi	5psi
80psi	75psi	62psi	45psi	21psi	-
60psi	55psi	40psi	25psi	5psi	-

To determine the correct performance data for your application, first shut off all flow on discharge side of pump and determine the shut-off pressure at the pump. Use this Shut-Off pressure to determine which line of data applies.

SPRAY OPERATION (CONTINUED)

One of the most common causes for faulty-pump performance is corrosion inside the pump. Flush the pump and entire system with a solution that will chemically neutralize the liquid pumped. Mix according to manufacturer's directions. This will dissolve most residue remaining in the pump, leaving the inside of the pump clean for the next use.

TO PREVENT CORROSION

After cleaning the pump as directed, flush it with a permanent type automobile antifreeze (Prestone, Zerex, etc.) containing a rust inhibitor. Use a 50% solution that is, half antifreeze and half water. Then coat the interior of the pump with a substance which will prevent corrosion such as Fluid Film or WD40. If unit will not be used for an extended period of time, disconnect hoses into and out of the pump, seal openings to the pump with caps or tape. Dispose of fluids according to all federal, state and local regulations.

NOTE: All chemicals and chemical residue must be removed after each use. Dispose of fluids and residue according to all federal, state and local regulations.

SPRAYER CLEANING

Empty tank and clean unit thoroughly after each use following these instructions:

1. Remove coupling and rinse inside of tank thoroughly with clean water, replace coupling.
2. Fill tank ten percent full with clean water, start pump and discharge water through spray hose or spray boom (with nozzles removed), until empty.
3. Remove drain coupling again and rinse tank interior thoroughly.
4. Rinse exterior of sprayer thoroughly with clean water.
5. Remove bowl from sprayer filter (on operators left hand side of the spray tank). Remove stainless steel screen. Wash bowl and screen thoroughly. Apply thin layer of petroleum jelly to O-ring or gasket. Replace screen and bowl, taking care to position O-ring or gasket properly. Hand tighten.

MANUAL HOSE REEL

Located at the back of the Spray Star behind the tank. Open the ball valve located near the pump to allow fluid to flow into the hose reel. Place the lockout pin in the unlocked position by pulling and turning it half a turn, this will allow you to pull out additional hose or to use the handle and wind up the hose. To prevent movement during transport or storage place the lockout pin in the locked position.

ELECTRIC HOSE REEL

Located at the back of the Spray Star behind the tank. Open the ball valve located near the pump to allow fluid to flow into the hose reel. To unwind hose just pull on the hose to get the desired amount. To wind up the hose make sure the toggle switch is in the ON position, push the momentary push button switch until you have reeled in the amount of hose desired. Turn off the safety switch when not in use.

FOAM MARKER

Located to the right of the control panel. Use lever (A) to designate which boom is to be used to dispense foam. Use dial (B) located on top of foamer to adjust pressure for the amount of foam that will be dispensed. Switch (A) also turns foamer on or off.

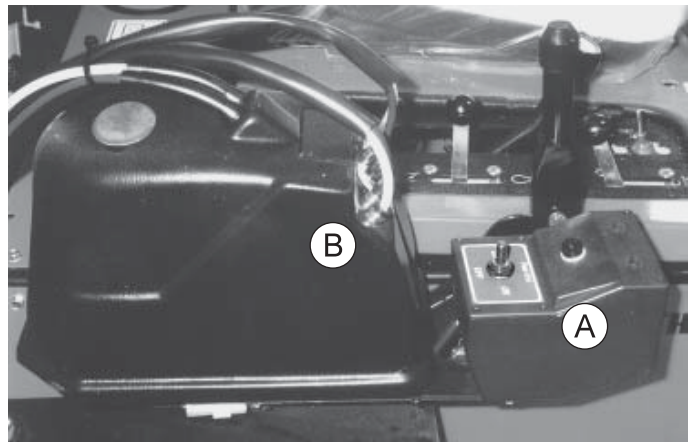

HYDRAULIC SCHEMATIC

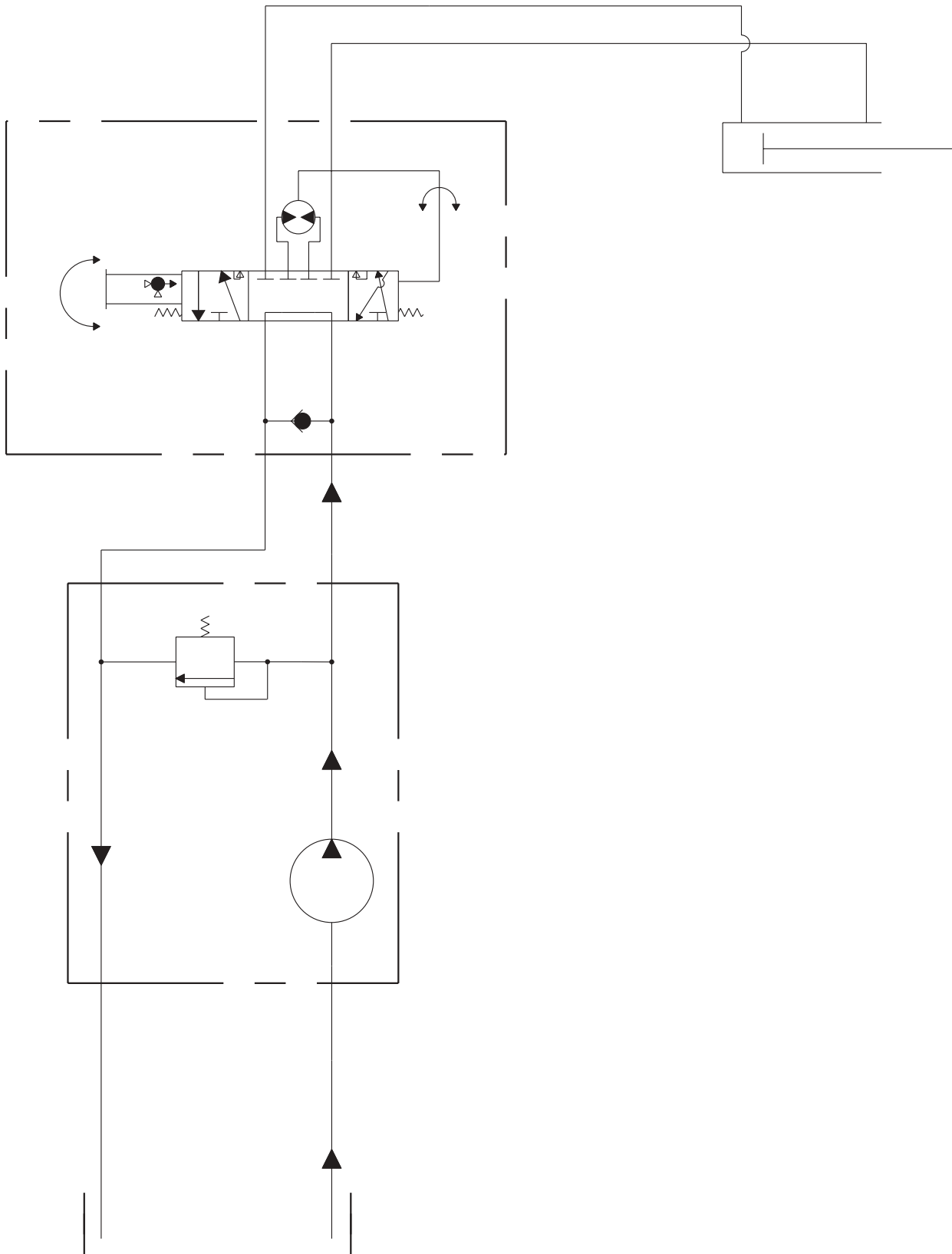

Schematics

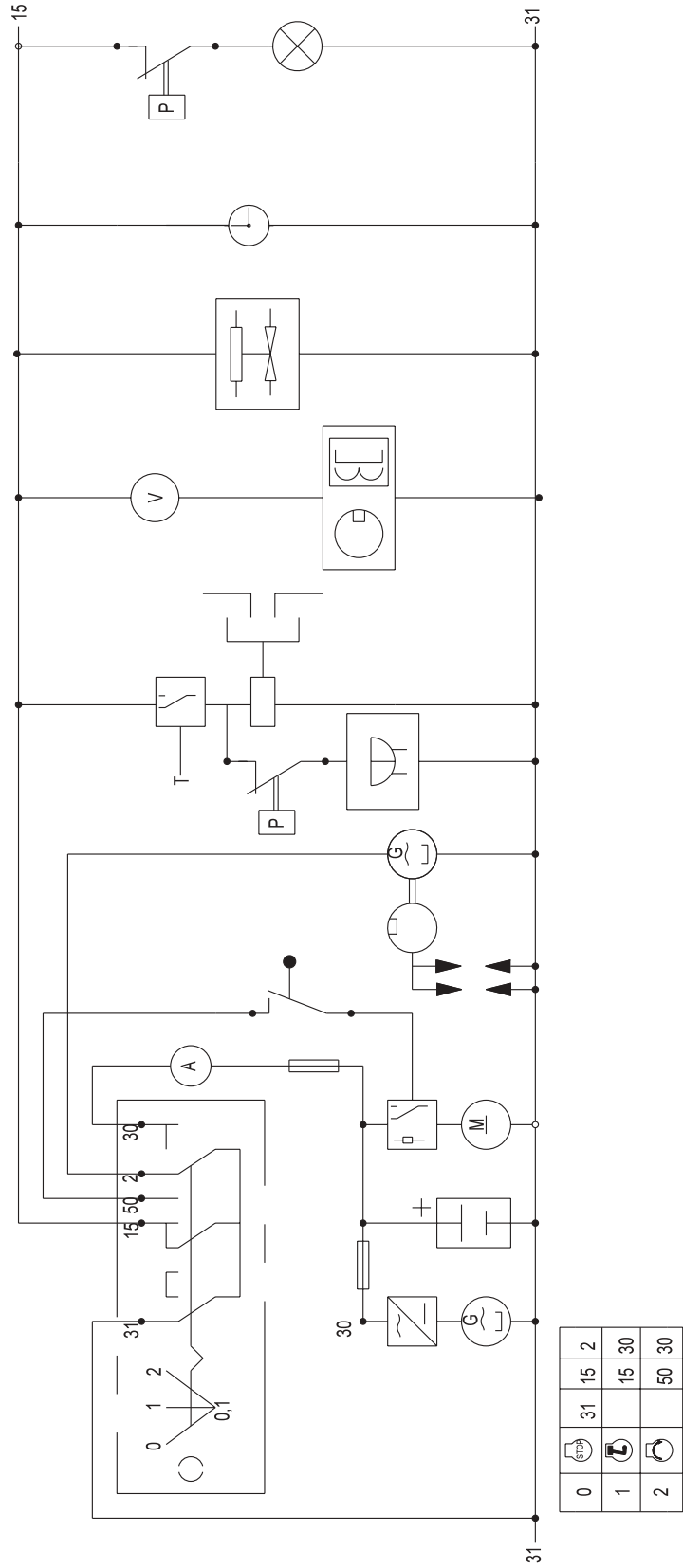

SPRAYING INTRODUCTION

This section is intended to offer practical guidelines for the distribution of liquid chemicals over an area of turfgrass such as golf courses, park land, school grounds and lawns. SMITHCO makes no representation as to the suitability of any technique or product for any particular situation. This section is suitable for self-propelled spray vehicles or sprayers mounted onto vehicles.

Boom Spraying is the most effective, accurate and efficient method of applying chemicals to large turf areas. It may be done by means of:

- A dedicated spray vehicle
- A sprayer mounted upon a utility vehicle

Sprayers are typically equipped with wide spray booms. Generally these booms are between 15 feet (4.5m) and 20 feet (6m) in width. They are divided into three sections, with hinges that permit the long outer sections to automatically move out of the way and reset if an obstacle such as a tree or fence is in your path.

To minimize the chance for missed areas or double application use a device to mark the outside boundaries of each spray swath. Foam markers and dye markers are advisable.

TURF MANAGEMENT

Turf management chemicals are made for four general purposes:

1. **Fungicides:** Prevent or cure fungus on turfgrass. They are made in 2 general types:
 - Systemic - Chemicals enter the plant system and protect or cure it of, fungus.
 - Contact - Kills fungus with which it comes into contact.
2. **Insecticides:** Eliminate damaging insects and worms (such as grubs, beetles, ants, etc.)
3. **Herbicides:** Control and eliminate undesirable weeds and grass from turf areas and non-turf areas such as bunkers, trails, fences, etc.
4. **Nutrients & Fertilizer:** Promote growth, beauty and color in turfgrass.

Some materials have to be applied so that they get into the soil below the plant leaves, This is called "*soil application*". In order to do this, they are best applied with a *large volume of water*. They are often then *watered-in* using the irrigation system. This type of chemical material includes systemic chemicals and chemicals designed to destroy pests which live in the thatch and the soil.

Other materials must be applied to reach a problem that is present on the plant leaves. This is called "*Foliar Application*" and requires a *lower volume* of water. Instead of irrigation water, these materials are further activated by dry air and sunshine. They include contact fungicide and many herbicides.

The user of sprayers and chemicals must follow the directions provided with the spray material. It is the only way to insure safe and effective results. It provides information on how much chemical and how much water is to be applied to the area to be sprayed.

Though there are many types and sizes of nozzles, two specific types have proven most successful in turfgrass management.

- The first type is **target-directed**. It sprays material in a direct line downwards to the target turfgrass. These are flat fan nozzles, commonly referred to as Tee-Jet nozzles. They are available in a wide variety of sizes for any required discharge volume rate. They are the best for many contact or foliar applied pest-icides. They are spaced either 10" (25cm) or 20" (51cm) apart and overlap one another by about 1/3.
- The second type useful in turf management are **broadcast** type nozzles. They are commonly referred to as turfjet or floodjet nozzles. They spray a hollow-cone shaped pattern of much larger droplets which fall quickly to the turf under their own weight. They are best for systemic pesticides or any material requiring a large volume of water for soil application. The larger droplets are not as subject to drift from wind and are a safer, more environmentally friendly choice in many situations.

A handgun (hand-nozzle or hand-lance) is used to control and direct the spray pattern to the ground, shrub or tree. They must be constructed of long lasting and noncorrosive materials such as brass, stainless or aluminum. The handgun fits to a hose of any length from the sprayer allowing operator mobility. The hose should be as short as possible while still permitting operator mobility.

Liquid loses pressure due to friction as it travels through the hose, 1-3 psi (0.07-0.21bar) for each foot (30cm) of hose. For most operations $\frac{1}{2}$ " (1.25cm) inside diameter hose is adequate. Trees over 40 ft (12m) high require $\frac{3}{4}$ " (2cm) inside diameter hose and a sprayer pump capable of delivering a volume of at least 20 gpm (75 lpm) and a pressure of at least 400 psi (28 bar).

NOZZLES

Always be alert to the possibility of a plugged or damaged nozzles. Serious misapplications may result. Check nozzle output periodically.

Modern nozzles use spring and diaphragm check valves to insure positive cutoff of chemicals without drip.

Snap-on caps make replacing and cleaning nozzles, quick, easy and fool proof with proper reinstallation.

An operator can see at a glance if all nozzles are the same size by the color code.

3 FUNCTIONS FOR A SPRAY BOOM NOZZLE

1. Regulating the flow is done through size of the orifice (opening) within the nozzle. All nozzles, regardless of type, have some point within them that regulates the flow of liquid. Obviously, the larger the opening the greater the rate of flow volume. Volume is expressed in Gallons Per Minute (gpm) or Liters Per Minute (lpm). Do not confuse the term volume with application rate, which will be covered later.

As pressure increases, the flow volume in a given nozzle also increases. For example, an average size nozzle which discharges 0.52 gpm (1.4 lpm) at 30 psi (2bar), will discharge 0.73 gpm (2 lpm) at 60 psi (4bar). In this example, an increase in pressure of 100% has caused an increase in discharge of 40%.

Some nozzles deliver a small volume (for example: 0.2 gpm (0.75LMP)). Some nozzles deliver a relatively large volume (for example: 1.5 gpm (5.7 lpm)), or $7\frac{1}{2}$ times as much as the smaller nozzle in this example.

The amount of material (volume) to be applied is determined by the effect the chemical has on the turf.

2. The nozzle on a sprayer is to form the liquid into droplets. The size of the droplet is determined by two factors design and system pressure (psi/bar).

Particular applications are done best by big droplets such as systemic fungicides, insecticides and some herbicides in order to reduce drift. Other applications require small droplets like contact fungicides and some herbicides. Again, this is determined by whether the chemical is foliar applied or soil applied.

Large droplets for soil applied material, small droplets for foliar applied materials that evenly cover the plant better.

Pressure also affects droplet size. More pressure at the same nozzle produces smaller droplets, more subject to drift. The general rule on pressure is to use the lowest pressure possible with just enough to form adequate spray nozzle patterns.

NOZZLES (CONTINUED)

- Disperse the material in a specific pattern that will insure even distribution of chemical across the swath covered by the boom.

As shown (to the right) the pattern formed by flat fan (TeeJet) nozzles would show most liquid concentrated at the center, then tapering off where it begins to overlap with the next nozzle—approximately $\frac{1}{3}$. The pattern of liquid dispersed by the hollow-cone is more even across its width. Each nozzle overlaps the adjoining nozzle by 100%. That is to say the area covered by each nozzle extends to the center of the two nozzles on either side.

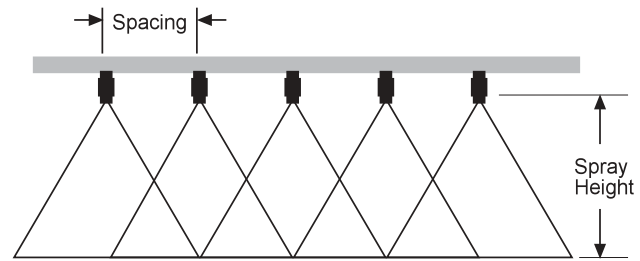

In order to properly develop their spray pattern, each nozzle must be the proper distance from the next nozzle (spacing) and the proper height above the ground.

NOZZLE SCREENS (STRAINERS)

Smaller nozzles require nozzle screens or strainers to prevent clogging.

- Teejet type nozzles size 8001 and 80015 require 100 mesh screens.
- Teejet type nozzles from size 8002 through 8008 require 50 mesh screens.
- Turbo TurfJet Nozzles Size 1/4 TTJ02-VS and larger do not require strainers.
- Turbo Floodjet Nozzles TF-VS2 through TF-VS3 require 50 mesh screens.
- Turbo Floodjet Nozzles TF-VS4 and larger do not require screens.

SPACING

Turf spray nozzles are normally 20" (51 cm) apart. Some cases 40" (101 cm), depending on the type of spray boom and type of area to be sprayed.

Very fine, level areas (golf greens and tees, bowling lawns, tennis courts, etc.) may be sprayed with nozzles spaced every 10" (25 cm).

BOOM HEIGHT

Height is very important in permitting spray nozzles to develop their proper spray pattern. If nozzles are too high, excessive overlap develops. If nozzles are too low, there is not enough overlapping of nozzle spray patterns.

NOZZLE TYPE	NOZZLE SPACING	HEIGHT ABOVE THE GROUND
80° Flat Fan	20" (51 cm)	18" (45 cm)
65° Flat Fan	20" (51 cm)	12" (30 cm)
Turbo TurfJet	20" (51 cm)	15" (38 cm)
Turbo TurfJet	40" (101 cm)	19" (48 cm)
Turbo Floodjet	20" (51 cm)	16" (41 cm)
Turbo Floodjet	40" (100 cm)	18" (45 cm)

Improper nozzle height or spacing prevents proper application of chemical. Some areas are under treated and chemicals are ineffective. Some areas are overtreated with wasted chemical and possible turf damage.

Operating your sprayer at a desired speed and pressure on a hard, dry surface is a good method of checking spraying consistency. Observe nozzles in operation, observe if the area dries evenly. If there are alternating wet and dry streaks, raise or lower the spray boom. If the wet streaks are directly under the nozzle, the boom is too low. If the wet streaks are between the nozzles, the boom is too high.

Calibrating simply means to adjust a set of variables on the sprayer in order to deliver the desired amount of chemical to a known area of turf.

The job of calibrating the sprayer consists of balancing these variables so that your sprayer delivers the desired application rate. That is, an amount of chemical on a given area. It is expressed as:

Gallons Per Acre (gpa) (1 US gpa = 0.83 UK gpa)

or **Gallons Per 1,000 Square Feet (gpt)**

or **Liters Per Hectare (lph)** (1 US gpa = 9.35 lph)

A number of acceptable methods for calibrating a turf sprayer are widely available. The calibration method chosen must take these variables into account. They must include known ground speed (by measurement or from an accurate speedometer) and nozzle output (gpm or lpm) from a nozzle chart or from actual measurement. The variables are:

PRESSURE

Just as pressure increases the volume discharge rate, it also increases the application rate. Pressure must increase by 4 times in order to double the application rate. Small pressure changes of 10 psi (1.4 bar) or less do not greatly affect performance.

Pressure is established and maintained by a pressure control valve or by a flow control valve located on the sprayer.

NOZZLE CAPACITY (VOLUME)

We have covered the different types of spray patterns of various nozzles and made our selection of type accordingly. We now have to choose a size which will provide the correct application rate.

Sizes are available for all requirements. Consult the nozzle chart in this manual for your nozzle type in order to select the correct size.

TRAVEL SPEED

Increased travel speed decreases the application rate (gpa, gpt or lph). Travel speed must be safe and appropriate for the area to be sprayed.

Unlike pressure changes which have only a minor effect on application rate, ground speed changes have a more major and direct effect. For example: 50% decrease in ground speed means a 100% increase in application rate. If the vehicle does not have an accurate speedometer, correct speed must be determined by timing the sprayer travel over a measured distance. (Refer to the page in this manual titled, "Abbreviations and Conversions").

To calibrate a sprayer, the user must:

1. **Understand** the Variables
2. **Set** those variables using one of the proven methods available.
3. **Make** a trial run and measure the output (use water, not chemical).
4. **Determine** the output.
5. **Make** adjustments to the 3 variables until the output is at the desired level.

This covers the principles of what must be known to prepare a sprayer for operation.

NOTE: There are other acceptable and proven methods of calibrating a turf sprayer for application. Other techniques may be more suitable depending on operational needs and technical competence of the operator.

THE NOZZLE CHART METHOD OF CALIBRATION

The Nozzle Chart Method is useful when the sprayer nozzles are new or nearly new. It is also the most useful method to employ when the sprayer is equipped with an Electronic Spray Control System. The Electronic Spray Control System does most of the calibration work, it is up to the operator to select the proper combination of nozzle size and ground speed which will deliver the desired application rate.

The nozzle chart method requires the use of the appropriate nozzle charts which are found in the back of this manual (Nozzle Charts 1 through 8). Nozzle charts for other nozzles are available from the manufacturer.

CALIBRATION STEPS

1. **Determine “HOW”** your sprayer is to be calibrated from the list of variables below.

- a. **Nozzle Type** (Teejet, Turbo Turf, Turbo Flood)
- b. **Spacing** (10" (25 cm) or 20" (51 cm) or 30" (76 cm))
- c. **Expression of Application Rate** (gpa or gpt or lph)

The answers to these three questions will direct you to the appropriate nozzle chart for your application. The correct nozzle chart **MUST** be used.

2. **Determine the Desired Application Rate.**

This is determined from the information on chemical labels or other technical information available from a variety of sources.

3. **Determine an Acceptable Ground Speed.**

Conditions over which the sprayer will operate generally dictate the appropriate ground speed. Within the limits of practicality and efficiency, spraying should generally be done at lowest possible speed. This increases operator safety and contributes to more precise application of chemicals. For example, golf greens and tees and hill areas would generally be sprayed in the range of 2¹/₂ to 3¹/₂ mph (4-6 kph). Larger, open and more level areas such as golf fairways and park or school grounds would be sprayed at 4¹/₂ to 6 mph (7-10 kph).

The vehicle which carries or tows the sprayer should be equipped with a precise low-speed speedometer. If it is not, exact ground speed at a given engine speed must be determined by timing the travel of the sprayer over a measured distance.

4. **Determine Nozzle Size.**

Refer to the appropriate nozzle chart in the back of this manual for your nozzle TYPE (the type of nozzle you have or type you wish to use), nozzle SPACING and CALIBRATION TYPE (gpm, gpt or lph).

You will note from the chart, that application rates from any given nozzle decrease as the ground speed increases. In other words, the faster you drive, the less material you are applying.

Application rates are shown in the columns to the right of the charts. Once the desired application rate is decided upon, it should be located, as nearly as possible in one of these columns on the appropriate chart for your operation. It could well be that the approximate rate desired would be obtained from the nozzles already installed in the boom. If this is not possible, then nozzles will need to be changed.

NOTE:

When selecting a new nozzle size refer to the “Discharge Rate Column” on the nozzle charts. The Discharge Rate (gpm or lpm) multiplied by the number of nozzles should not exceed 75% of the actual discharge volume of the sprayer pump. [i.e., if you need to use nozzles which discharge 0.8 gpm (3.0 lpm), and the spray boom is equipped with 12 nozzles, the sprayer pump would have to produce an actual discharge volume of 13 gpm (49 lpm) in order to properly supply these nozzles.] If the collective volume of the spray boom nozzles exceeds the actual discharge volume of the pump, inadequate pressure and poor nozzle distribution patterns may result.

Once nozzle type and size have been determined, those nozzles are installed in the sprayer boom. Nozzles should be expected to be replaced after 15-20 hours of actual sprayer operation. After nozzles are installed, make trial application of water over a known area to check application rate.

THE NOZZLE CHART METHOD OF CALIBRATION (CONTINUED)

5. For Sprayer with Electronic Spray Control Systems.

On sprayers equipped with Electronic Spray Control Systems such as those manufactured by Raven Ind., Micro-Trak Co. and Dickey-John Co., it is still important to select the right type and size of nozzle for the required operation. Electronic Spray Control Systems cannot function properly if the nozzles are not capable of delivering the programmed (desired) application rate. Nozzles which are too large will not develop adequate pressure or satisfactory spray patterns. Nozzles which are too small will not allow the discharge of spray material at the programmed application rate.

Further, when calibrating sprayers which are equipped with Electronic Spray Control Systems, care must be taken to use the mode of operation on the Spray Control System (Gallons per acre "US" Mode); Gallons per 1,000 Square Feet ("Turf" Mode); or Liters per Hectare (Standard International Model), which corresponds with the nozzle calibration charts (gpa, gpt or lph).

6. Using the Nozzle Charts.

Select the correct chart based on your nozzle type, nozzle spacing and desired expression of application rate (gpa, gpt or lph). If the desired operating speed is not found on the nozzle chart, it is simple to determine application rate at different speeds by estimating from the known facts.

Example 1: If the desired speed is 2½ MPH (4 kph) on a sprayer using TurfJet nozzles (Chart 5). The average between the application rates for 2 MPH and 3 MPH may be assumed to be the application rate for 2½ MPH.

Example 2: The desired speed is 6 MPH. Use the application rate column for 3 MPH a divide by 2.

7. Converting Nozzle Chart Method to British Gallons.

To convert any of the Gallon Per Acre rates to Imperial Gallons per acre, (Imp gpa) multiply by 0.83. To convert any of the Liter Per Hectare rates to Imperial Gallons Per Hectare (Imp GPH), multiply by 0.22.

8. Checking the Actual Application Rate.

After the combination of ground speed, nozzle size and operating pressure has been selected, the sprayer should be operated with water only to determine if the target application rate is achieved.

THE "128" METHOD OF BOOM SPRAYER CALIBRATION

The "128" Method is useful for calibrating sprayers and also for checking the calibration of sprayer calibrated by the Nozzle Chart Method and sprayers using Electronic Spray Control Systems. The "128" is based on a convenient mathematical relationship that exists between US Gallons, liquid ounces and acres.

An ounce is 1/128th of a (US) gallon. If an area which was "1/128th of an acre" could be found, the number of ounces applied to that small area would be equal to the number of gallons applied to the acre Thus, no mathematical computations would be required.

To determine an area which is 1/128 of an acre:

- On nozzles with 20 inch (51 cm) spacing, measure off a distance of 204 ft (62 meters). Mark a "START" and a "STOP" line. The rectangle formed by this distance and the spraying width of one nozzle 20" (51 cm) is equal to 340 square feet which is equal to 1/128 acre. Therefore, the amount of material applied to this area by one nozzle in OUNCES is the same amount of material applied to an acre in GALLONS (gpa).
- On nozzles with 10 inch (25 cm) spacing, the measure distance is 408 feet (124 meters).
- On nozzles with 30 inch (76 cm) spacing the measured distance is 136 feet (41 meters).

CALIBRATING FOR APPLICATION

1. Fill the sprayer tank with water. Run the sprayer, inspect it for leaks and make sure all systems function properly.
2. Drive the sprayer through the measured distance discussed above at normal spraying speed, record the travel time required to cover the measured distance in seconds with a stopwatch.

THE "128" METHOD OF BOOM SPRAYER CALIBRATION (CONTINUED)

The carrying or towing vehicle is to be traveling at the desired speed when it crosses the start line of the measured course.

Repeat this procedure and determine the average of the two times.

3. With the sprayer parked, run the sprayer at the required pressure level. Catch the output of each nozzle in a container which is marked or graduated in Ounces for the exact same period of time which it took the sprayer to cover the measured course in step #2. It is necessary to operate the vehicle engine at spraying speed using a hand throttle.
4. Observe the volume of water in the collection bottle. The number of OUNCES collected in the time it takes to cover the marked course. Take the average nozzle output by adding the outputs of each nozzle and then dividing that sum by the number of nozzles.

The NUMBER OF OUNCES collected in the time required to cover the SMALL AREA is equal to the NUMBER OF GALLONS applied per ACRE. For example: if an average of 40 ounces of water is collected in the time required to cover the 1/128 acre area, the application rate is 40 gallons per acre (gpa).

NOTE: As a practical matter, if high application rates are desired (above 75 gpa), the measured course length should be reduced by half (i.e. 102 ft (31 m) for 20 inch (52 cm) spaced nozzles). The volume collected (above) is then doubled (multiplied by 2).

AVERAGE OUTPUT (Ounces) = APPLICATION RATE (gpa)

5. Observe individual nozzle output volumes. If an individual nozzle is 10% above or below the average output, check for blockages in the nozzle or in the nozzle strainer. If the nozzle is worn or damaged, replace it.
6. Compare this actual application rate with the recommended rate. If the actual rate is more than 5% higher or lower than the intended rate, adjustments must be made.
7. Minor adjustments in application rate may be made by increasing or decreasing the spraying pressure. Lowering spraying pressure decreases application rate. Increasing spraying pressure increases application rate. This procedure normally does not apply to spray systems controlled by an Electronic Spray Control System, which governs flow rate.
8. Adjustments in application rate may be made by increasing or decreasing the travel speed of the sprayer if conditions permit. Slower speeds increase application rate. Faster speeds decrease application rate.
9. Nozzle sizes can be changed to provide the correct application rate. Refer to the nozzle charts in this book for the desired nozzle type.
10. Re-calibrate the sprayer (steps 2-6) after any adjustments are made.

As previously discussed, there are other acceptable methods of Turf Sprayer Calibration. Chemical suppliers, Agricultural Extension Agents, Universities and consultants of various types offer helpful advice on this subject. Technical catalogues are available from nozzle manufacturers.

TRANSFERRING THE "128" METHOD INTO METRIC (LITERS PER HECTARE)

The same steps are used that are used when calibrating in gallons per acre. First a relationship between a measurable amount (milliliters) and the calibration amount (liter) is determined. That ratio is 1:1000.

Now an area which is 1/1000th of a hectare must be measured.

On spray booms with 51 cm (20 inch) spacing, mark off an area which is 20 meters (65.6 feet) long. The area formed by that length and the width of one spray nozzle (20 meters by 0.5 meters) is 10 square meters which is 1/1000 of a hectare. Therefore, the amount of spray material applied to this small area in milliliters is equal to the amount applied to one hectare in liters.

Then, follow the remaining steps 2-10, substituting milliliters for ounces, liters for gallons, square meters for square feet and hectares for acres.

AVERAGE OUTPUT (Milliliters) = APPLICATION RATE (LITERS/HECTARE)

NOZZLE PERFORMANCE CHART #1

Nozzle Type:		XR TeeJet & DG TeeJet									
Spacing:		20 inch (51cm)									
Calibration:		US Gal/Acre (GPA) & US Gal/1,000 Square Feet (GPT)									
Color	Size	Pressure psi	Nozzle Capacity (Gal/Min)	Application Rate GPA				Application Rate GPT			
				Speed MPH				Speed MPH			
				4	5	6	7	2	3	4	5
Orange	XR8001	20	0.071	5.3	4.2	3.5	3.0	0.24	0.16	0.12	0.10
		30	0.087	6.5	5.2	4.3	3.7	0.31	0.21	0.16	0.11
		40	0.10	7.4	5.9	5.0	4.2	0.34	0.23	0.17	0.14
		60	0.12	8.9	7.1	5.9	5.1	0.41	0.28	0.21	0.16
Green	XR80015 DG80015	20	0.11	8.2	6.5	5.4	4.7	0.38	0.25	0.19	0.15
		30	0.13	9.7	7.7	6.4	5.5	0.44	0.30	0.22	0.18
		40	0.15	11.1	8.9	7.4	6.4	0.51	0.34	0.26	0.20
		60	0.18	12.6	10.7	8.9	7.6	0.61	0.41	0.31	0.25
Yellow	XR8002 DG8002	20	0.14	10.4	8.3	6.9	5.9	0.48	0.32	0.24	0.19
		30	0.17	12.6	10.1	8.4	7.2	0.58	0.39	0.29	0.23
		40	0.20	14.96	11.9	9.9	8.5	0.68	0.45	0.34	0.27
		60	0.24	17.8	13.1	11.9	10.2	0.82	0.54	0.41	0.33
Blue	XR8003 DG8003	20	0.21	15.6	12.5	10.4	8.9	0.72	0.48	0.36	0.29
		30	0.26	19.3	15.4	12.9	11.0	0.89	0.59	0.44	0.35
		40	0.30	22.0	17.8	14.9	12.7	1.02	0.68	0.51	0.41
		60	0.37	27.0	22.0	18.3	15.7	1.26	0.84	0.63	0.50
Red	XR8004 DG8004	20	0.28	21.0	16.6	13.9	11.9	0.98	0.64	0.48	0.38
		30	0.35	26.0	21.0	17.3	14.9	1.20	0.80	0.60	0.48
		40	0.40	30.0	24.0	19.8	17.0	1.40	0.91	0.68	0.55
		60	0.49	36.0	29.0	24.0	21.0	1.70	1.10	0.84	0.67
Brown	XR8005 DG8005	20	0.35	26.0	21.0	17.3	14.9	1.20	0.80	0.60	0.48
		30	0.43	32.0	26.0	21.0	18.2	1.50	0.98	0.73	0.59
		40	0.50	37.0	30.0	25.0	21.0	1.70	1.10	0.85	0.68
		60	0.61	45.0	36.0	30.0	26.0	2.10	1.40	1.00	0.83
Gray	XR8006	20	0.42	31.0	25.0	21.0	17.8	1.40	0.95	0.72	0.57
		30	0.52	39.0	31.0	26.0	22.0	1.80	1.20	0.89	0.57
		40	0.60	45.0	36.0	30.0	25.0	2.00	1.40	1.00	0.82
		60	0.73	54.0	43.0	36.0	31.0	2.50	1.70	1.20	0.99
White	XR8008	20	0.57	42.0	34.0	28.0	24.0	1.90	1.30	0.97	0.78
		30	0.69	51.0	41.0	34.0	29.0	2.40	1.60	1.20	0.94
		40	0.80	59.0	48.0	40.0	34.0	2.70	1.80	1.40	1.10
		60	0.98	73.0	58.0	49.0	42.0	3.30	2.20	1.70	1.30
Steel	SS8010	40	1.00	128	74.0	59.0	50.0	3.40	2.30	1.70	1.40
		60	1.20	156	91.0	72.0	60.0	4.10	2.80	2.10	1.70

NOZZLE PERFORMANCE CHART #2

Nozzle Type: Spacing: Calibration:		XR TeeJet & DG TeeJet 20 inch (51cm) Liters Per hectare									
Color	Size	Pressure bar	Nozzle Capacity (l/min)	Application Rate l/ha Speed km/h							
				4	5	6	7				
Orange	XR8001	1.5	0.28	84	67.2	56.0	48.0				
		2.0	0.32	96	76.8	64.0	54.9				
		3.0	0.39	117	93.6	78.0	66.9				
		4.0	0.45	135	108	90.0	77.1				
Green	XR80015 DG80015	1.5	0.42	126	101	84.0	72.0				
		2.0	0.48	144	115	96.0	82.3				
		3.0	0.59	177	142	118	101				
		4.0	0.68	204	163	136	117				
Yellow	XR8002 DG8002	1.5	0.56	168	134	112	96.0				
		2.0	0.65	195	156	130	111				
		3.0	0.79	237	190	158	135				
		4.0	0.91	273	218	182	156				
Blue	XR8003 DG8003	1.5	0.83	249	199	166	142				
		2.0	0.96	288	230	192	165				
		3.0	1.18	354	283	236	202				
		4.0	1.36	408	326	272	233				
Red	XR8004 DG8004	1.5	1.12	336	269	224	192				
		2.0	1.29	387	310	258	221				
		3.0	1.58	474	379	316	271				
		4.0	1.82	546	437	364	312				
Brown	XR8005 DG8005	1.5	1.39	417	334	278	238				
		2.0	1.61	483	386	322	276				
		3.0	1.97	591	473	394	338				
		4.0	2.27	681	545	454	389				
Gray	XR8006	1.5	1.68	504	403	336	288				
		2.0	1.94	582	466	388	333				
		3.0	2.37	711	569	474	406				
		4.0	2.74	822	658	548	470				
White	XR8008	1.5	2.23	669	535	446	382				
		2.0	2.58	774	619	516	442				
		3.0	3.16	948	758	632	542				
		4.0	3.65	1095	876	730	626				
Steel	SS8010	3.0	3.95	1185	948	790	677				
		4.0	4.56	1368	1094	912	782				

NOZZLE PERFORMANCE CHART #3

Nozzle Type:		Turbo FloodJet									
Spacing:		40 inch (100cm)									
Calibration:		US Gal/Acre (GPA) & US Gal/1,000 Square Feet (GPT)									
Color	Size	Pressure psi	Nozzle Capacity (Gal/Min)	Application Rate GPA Speed MPH				Application Rate GPT Speed MPH			
				4	5	6	7	4	5	6	7
Red	TF-VS2	20	0.28	10.4	8.3	6.9	5.9	.24			
		30	0.35	13.0	10.4	8.7	7.4	.30			
Brown	TF-VS2.5	20	0.35	13.0	10.4	8.7	7.4	.30			
		30	0.43	16.0	12.8	10.6	9.1	.37			
Gray	TF-VS3	20	0.42	15.6	12.5	10.4	8.9	.36			
		30	0.52	19.3	15.4	12.9	11.0	.44			
White	TF-VS4	20	0.57	21.0	16.9	14.1	12.1	.48			
		30	0.69	26.0	20.0	17.1	14.6	.59			
Blue	TF-VS5	20	0.71	26.0	21.0	17.6	15.1	.60			
		30	0.87	32.0	26.0	22.0	18.5	.74			
Green	TF-VS7.5	20	1.06	39.0	31.0	26.0	22.0	.90			
		30	1.30	48.0	39.0	32.0	28.0	1.11			
Black	TF-VS10	20	1.41	52.0	42.0	35.0	30.0	1.20			
		30	1.73	64.0	51.0	43.0	37.0	1.47			

NOZZLE PERFORMANCE CHART #4

Nozzle Type:		Turbo FloodJet									
Spacing:		40 inch (100cm)									
Calibration:		Liters Per Hectare									
Color	Size	Pressure bar	Nozzle Capacity (l/min)	Application Rate l/ha Speed km/h				Application Rate GPT Speed MPH			
				4	6	8	10				
Red	TF-VP2	1.5	1.11	167	111	83.3	66.6				
		2.0	1.29	194	129	96.8	77.4				
Brown	TF-VP2.5	1.5	1.40	210	140	105	84.0				
		2.0	1.61	242	161	121	96.6				
Gray	TF-VP3	1.5	1.68	252	168	126	101				
		2.0	1.94	291	194	146	116				
White	TF-VP4	1.5	2.23	335	223	167	112				
		2.0	2.57	386	257	193	129				
Blue	TF-VP5	1.5	2.79	419	279	209	167				
		2.0	3.22	483	322	242	193				
Green	TF-VP7.5	1.5	4.19	629	419	314	251				
		2.0	4.83	726	484	363	290				
Black	TF-VP10	1.5	5.58	837	558	419	335				
		2.0	6.45	968	645	484	387				

NOZZLE PERFORMANCE CHART #5

Nozzle Type:		Turbo TurfJet									
Spacing:		20 inch (51cm)									
Calibration:		US Gal/Acre (GPA) & US Gal/1,000 Square Feet (GPT)									
Color	Size	Pressure psi	Nozzle Capacity (Gal/Min)	Application Rate GPA				Application Rate GPT			
				Speed MPH (KPH)				Speed MPH (KPH)			
				3 (5)	4 (6)	5 (8)	6 (10)	3 (5)	4 (6)	5 (8)	6 (10)
Yellow	1/4 TTJ02-VS	25	.16	15.8	11.9	9.5	7.9	.36	.27	.22	.18
		30	.17	16.8	12.6	10.1	8.4	.39	.29	.23	.19
		40	.20	19.8	14.9	11.9	9.9	.45	.34	.27	.23
		50	.22	22	16.3	13.1	10.9	.50	.37	.30	.25
Red	1/4 TTJ04-VS	25	.32	32	24	19.0	15.8	.73	.54	.44	.36
		30	.35	35	26	21	17.3	.79	.60	.48	.40
		40	.40	40	30	24	19.8	.91	.68	.54	.45
		50	.45	45	33	27	22	1.0	.77	.61	.51
Brown	1/4 TTJ05-VS	25	.40	40	30	24	19.8	.91	.68	.54	.45
		30	.43	43	32	26	21	.97	.73	.58	.49
		40	.50	50	37	30	25	1.1	.85	.68	.57
		50	.56	55	42	33	28	1.3	.95	.76	.63
Gray	1/4 TTJ06-VS	25	.47	47	35	28	23	1.1	.80	.64	.53
		30	.52	51	39	31	26	1.2	.88	.71	.59
		40	.60	59	45	36	30	1.4	1.0	.82	.68
		50	.67	66	50	40	33	1.5	1.1	.91	.76
White	1/4 TTJ08-VS	25	.63	62	47	37	31	1.4	1.1	.86	.71
		30	.69	68	41	41	34	1.6	1.2	.94	.78
		40	.80	79	59	48	40	1.8	1.4	1.1	.91
		50	.89	88	66	53	44	2.0	1.5	1.2	1.0
L. Blue	1/4 TTJ10-VS	25	.79	78	59	47	39	1.8	1.3	1.1	.90
		30	.87	86	65	52	43	2.0	1.5	1.2	.99
		40	1.00	99	74	59	50	2.3	1.7	1.4	1.1
		50	1.12	111	83	67	55	2.5	1.9	1.5	1.3
L. Green	1/4 TTJ15-VS	25	1.19	118	88	71	59	2.7	2.0	1.6	1.3
		30	1.30	129	97	77	64	2.9	2.2	1.8	1.5
		40	1.50	149	111	89	74	3.4	2.6	2.0	1.7
		50	1.68	166	125	100	83	3.8	2.9	2.3	1.9

Nozzle Charts

NOZZLE PERFORMANCE CHART #6

Nozzle Type: Spacing: Calibration:		Turbo TurfJet 20 inch (51cm) Liters Per Hectare									
Color	Size	Pressure bar	Nozzle Capacity (l/min)	Application Rate l/ha Speed KPH (MPH)							
				4 (2.5)	6 (4)	8 (5)	10 (6)				
Yellow	1/4 TTJ02-VP	1.0	0.46	69.0	46.0	34.5	27.6				
		1.5	0.56	84.0	56.0	42.0	33.6				
		2.0	0.65	97.5	65.0	48.8	32.5				
		3.0	0.80	120.0	80.0	60.0	48.0				
Red	1/4 TTJ04-VP	1.0	.091	137	91.0	68.3	54.6				
		1.5	1.11	167	111	83.3	66.6				
		2.0	1.29	194	129	95.8	77.4				
		3.0	1.58	237	158	119	94.8				
Brown	1/4 TTJ05-VP	1.0	1.14	171	114	85.5	68.4				
		1.5	1.40	210	140	105	84.0				
		2.0	1.61	242	161	121	96.6				
		3.0	1.97	296	197	148	118				
Gray	1/4 TTJ06-VP	1.0	1.37	206	137	103	82.2				
		1.5	1.68	252	168	126	101				
		2.0	1.94	291	194	146	116				
		3.0	2.37	356	237	178	142				
White	1/4 TTJ08-VP	1.0	1.82	273	182	137	109				
		1.5	2.23	335	223	167	134				
		2.0	2.57	385	257	193	154				
		3.0	3.15	473	315	236	189				
L. Blue	1/4 TTJ10-VP	1.0	2.28	342	228	171	137				
		1.5	2.79	419	279	209	167				
		2.0	3.22	483	322	242	193				
		3.0	3.95	593	395	295	237				
L. Green	1/4 TTJ15-VP	1.0	3.42	513	342	257	205				
		1.5	4.19	629	419	314	251				
		2.0	4.84	726	484	363	290				
		3.0	5.92	888	592	444	355				

ABBREVIATIONS AND CONVERSIONS

gpm	Gallons per minute	cm	Centimeters
lit/min	Liters per minute	dm	Decimeters
dl/min	Deciliter per minute	m	Meter
psi	Pounds per square inch	mm	Millimeters
km	Kilometers	m.p.h.	Miles per hour
gpa	Gallon per acre	km/h	Kilometers per hour
lit/ha	Liters per hectare	us	Volume per ACRE
ml/ha	Milliliter per hectare	Si	Volume per HECTARE
gpk	Gallons per 1,000 sq ft	TU	Volume per 1,000 sq ft

AREA & SPEED

Distance (feet) x 0.68 = Travel Speed (m.p.h.) Travel Time (seconds)

Time Required in Seconds to Travel a Distance of:

Speed (m.p.h.)	100 ft	200 ft	300 ft
1.0	68	136	205
1.5	46	92	136
2.0	34	68	103
2.5	27	54	82
3.0	23	46	68
3.5	20	40	58
4.0	17	34	52
4.5	15	30	46
5.0	13	28	41

LIQUID/VOLUME

1 US Gallon x 128 = Fluid Ounces

1 US Gallon x 3.785 = Liters

1 US Gallon x 0.83267 = Imperial Gallons

1 US Gallon x 8.34 = Pounds (Water)

1 Gallon Per Acre = 2.9 Fluid Ounces per 1,000 Square Feet = 9.35 Liters Per Hectare

1 Gallon Per 1,000 Square Feet = 43.56 Gallons Per Acre

1 Gallon = 128 Fluid Ounces = 8 Pints = 4 Quarts = 3.79 Liters = 0.83 Imperial Gallons

$$\text{gpa} = \frac{5940 \times \text{GPM (per nozzle)}}{\text{MPH} \times \text{Nozzle Spacing Width (inches)}}$$

$$\text{GAL. 1,000 Square Feet} = \frac{136 \times \text{GPM (per nozzle)}}{\text{MPH} \times \text{Nozzle Spacing Width (inches)}}$$

LENGTH/DISTANCE

1 millimeter (mm) = 0.039 inch

1 centimeter (cm) = 0.393 inch

1 meter (m) = 3.281 feet

1 kilometer (km) = 0.621 mile

1 inch = 25.4 millimeters; 2.54 centimeters

1 mile = 5280 Feet = 1610 Meters = 1.609 Kilometers

PRESSURE

1 Pound Per Square Inch = 0.069 Bar

AREA

1 square meter = 10.764 sq feet

1 hectare (ha) = 2.471 acres = 10,000 sq meters

1 acre = 0.405 hectare = 43,560 Square Feet

1 sq mile = 640 acres = 258.9 hectares

EC DECLARATION OF CONFORMITY

according to Directive 89/392/EEC

We SMITHCO INC.
(Name of supplier)

34 West Ave. Wayne, PA 19087 USA

(Full address of the manufacture - authorized representative established in the Community must also give the business name and address of the manufacture)

declare under our sole responsibility, that the product

Spray Star 1600P \ 14-300-A

(Make, Model)

to which this declaration relates corresponds to the relevant basic safety and health requirements of the Directive 89/392/EEC,

(if applicable)

and to the requirements of the other Directives:

EN292-1

EN292-2

EN294

EN349

92/59

89/392

(Title and/or number and date of issue of the other Directives)

(if applicable)

For the relevant implementation of the safety and health requirements mentioned in the Directives, the following standard(s) and/or technical specification(s) has (have) been respected:

ISO 37-1983

PREN 836

ISO 1219-1976

SAE HS-2800

SAE J1362

(Title and/or number and date of issue of standard(s) and/or technical specification(s))

Cameron, Wisconsin USA

March 19, 1995

(Place and date of issue)

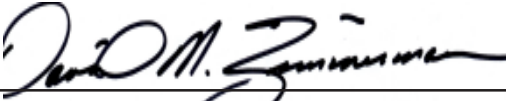
(Name, function and signature of the authorized person)

LIMITED WARRANTY

SMITHCO warrants this product to be free from defects in material and workmanship under normal use for one year from the date of purchase by the original user. (60 days if product is used for rental purposes.) All warranty claims must be handled through a SMITHCO authorized dealer or by SMITHCO, INC. All transportation charges must be paid by the purchaser.

There is no further express warranty. All implied warranties, including those of merchantability and fitness for a particular purpose, are limited to one year, (60 days if product is used for rental purposes) from the date of purchase by the original user, and to the extent permitted by law any and all implied warranties are excluded and disclaimed after the expiration of such period.

All incidental and consequential damages, including pickup and delivery of the unit, communication, mileage charges and/or rental of a replacement unit during repair, are not covered under this warranty, nor is any loss of income and/or other loss resulting from the failure of the product to function due to a warranty defect.

The following items are not covered under the SMITHCO warranty, and are warranted by their respective manufacturer.

- (a) Engine and engine parts, including starters, generators, alternators and filters.
- (b) Transaxle, differentials, gear boxes and mechanical pumps.
- (c) Hydrostatic transmissions, hydraulic pumps and motors.
- (d) Batteries.
- (e) Wheels and tires.

A copy of the warranty for the above items is furnished if necessary with each SMITHCO product.

Some states do not allow limitations on how long an implied warranty lasts, or the exclusion or limitations of incidental or consequential damages, so the above limitations or exclusions may not apply to you. This warranty gives you specific legal rights and you may also have other rights, which may vary from state to state.

Federal law now requires disclosure of the warranty which applies to this product prior to the sale to a customer. Please leave this statement attached to the product and allow the buyer to remove it after purchase.

SMITHCO

Wayne, Pennsylvania 19087

