

**SMITHCO**

Wayne, Pennsylvania 19087

# **BUNKER RAKE OPERATOR'S MANUAL**

## **SUPER STAR**

Model 42-000-D and 42-001-D

## **SUPER RAKE**

Gas Model 13-550-D and 13-551-D  
Diesel Model 17-001-D

**November, 2003  
ENGLISH**

SMITHCO PRODUCT SUPPORT

1-800-891-9435

Hwy SS and Poplar Avenue, Cameron WI 54822

E-mail: [productsupport@smithco.com](mailto:productsupport@smithco.com)

# CONTENTS

<b>Introduction</b> .....	<b>1-13</b>
Introduction .....	1
Symbols .....	2-3
Safe Practices .....	4
Super Star Specifications .....	5
Super Rake Gas and Diesel Specifications .....	6
Setup .....	7
Controls & Instruments Gas Super Rake .....	8
Controls & Instruments Diesel Super Rake .....	9
Controls & Instruments Super Star .....	10
Operation .....	11
Daily Checklist .....	12
How To Rake A Sand Trap .....	13
<b>Service</b> .....	<b>14</b>
Battery .....	14
<b>Other</b> .....	<b>15</b>
Declaration of Conformity .....	15
Limited Warranty .....	Inside Back Cover

Introduction

Service

Diagrams

Thank you for purchasing a **SMITHCO** product.

Read this manual and all other manuals pertaining to the Bunker Rake carefully as they contain safety, operating, assembly and maintenance instructions. Failure to do so could result in personal injury or equipment damage.

Keep manuals in a safe place after operator and maintenance personnel have read them. Right and left sides are from the operator's seat, facing forward.

All **SMITHCO** machines have a Serial Number and Model Number. Both numbers are needed when ordering parts. Refer to engine manual for placement of engine serial number.

The serial number plate on the Super Rakes is located on the right side main frame.

The serial number plate for the Super Star is located on the rear axle.











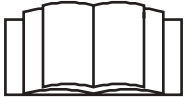



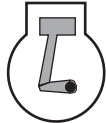
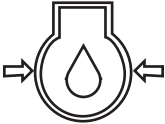

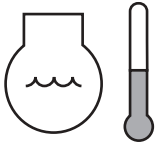
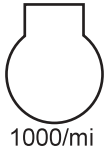
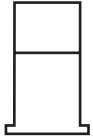

For easy access record your Serial and Model numbers here.

<b>SMITHCO</b>		DATE OF MFG.
WAYNE, PENNSYLVANIA 19087 USA 610-688-4009 Fax 610-688-6069		<input type="text"/>
SERIAL NO.	<input type="text"/>	kW/hp <input type="text"/>
MODEL NO.	<input type="text"/>	kg/lb <input type="text"/>

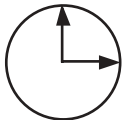
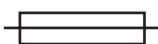
Information needed when ordering replacement parts:

1. Model Number of machine
2. Serial Number of machine
3. Name and Part Number of part
4. Quantity of parts

# SYMBOLS

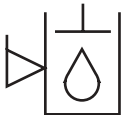
	Read Operator's Manual		Electrical Power		No Electrical Power
	Engine - Stop		Engine - Start		Engine - Run
	Engine Oil		Temperature Light		Water Temperature
	RPM 1000/mi		Gasoline		Diesel
	Glow Plug - On		Glow Plug - Off		Glow Plug
	Hour Meter		Hour Meter		Fuse
	Hand Throttle		Choke - Closed		Choke - Open
	Park Brake		Park Brake Release		Hydraulic Oil Level



Up/Down Arrow

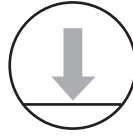

Down/Lower

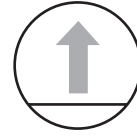

Up/Raise



No Smoking

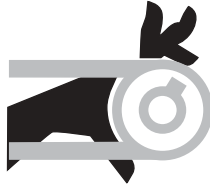

Moving Parts

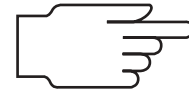

Manual Operation



Pinch Point



Step



Hot Surface

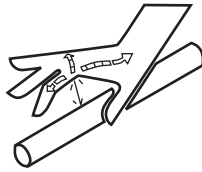

Hydraulic Fluid Penetration

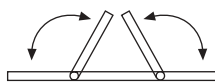

Lift Arm

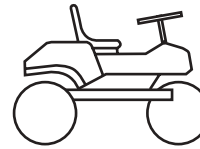

Tractor



Engage



Disengage

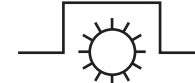

PTO

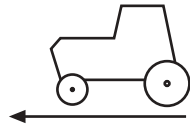

Ground Speed



Fast



Slow

**H**

High

**L**

Low

**F**

Forward

**R**

Reverse

**N**

Neutral



Warning  
Danger  
Caution

## SAFE PRACTICES

1. It is your responsibility to read this manual and all publications associated with this machine (engine, accessories and attachments).
2. Never allow anyone to operate or service the machine or its attachments without proper training and instructions. Never allow minors to operate any equipment.
3. Learn the proper use of the machine, the location and purpose of all the controls and gauges before you operate the equipment. Working with unfamiliar equipment can lead to accidents.
4. Wear all Personal Protective Equipment (PPE) on your head, eyes, ears, hands and feet. Operate the machine only in daylight or in good artificial light.
5. Inspect the area where the equipment will be used. Pick up all debris you can find before operating. Beware of overhead obstructions and underground obstacles. Stay alert for hidden hazards.
6. Never operate equipment that is not in perfect working order or without decals, guards, shields, or other protective devices in place.
7. Never disconnect or bypass any switch.
8. Carbon monoxide in the exhaust fumes can be fatal when inhaled, never operate a machine without proper ventilation.
9. Fuel is highly flammable, handle with care.
10. Keep engine clean. Allow the engine to cool before storing and always remove the ignition key.
11. After engine has started machine must not move. If movement is evident, the neutral mechanism is not adjusted correctly. Shut engine off and readjust so the machine does not move when in neutral position.
13. Never use your hands to search for oil leaks. Hydraulic fluid under pressure can penetrate the skin and cause serious injury.
14. This machine demands your attention. To prevent loss of control or tipping of the vehicle:
  - A. Use extra caution in backing up the vehicle. Ensure area is clear.
  - B. Do not stop or start suddenly on any slope.
  - C. Reduce speed on slopes and in sharp turns. Use caution when changing directions on slopes.
  - D. Stay alert for holes in the terrain and other hidden hazards.
15. Before leaving operator's position for any reason:
  - A. Disengage all drives.
  - B. Lower all attachments to the ground.
  - C. Set park brake.
  - D. Shut engine off and remove the ignition key.
16. Keep hands, feet and clothing away from moving parts. Wait for all movement to stop before you clean, adjust or service the machine.
17. Keep the area of operation clear of all bystanders.
18. Never carry passengers.
19. Stop engine before making repairs/adjustments or checking/adding oil to the crankcase.
20. Use parts and materials supplied by SMITHCO only. Do not modify any function or part.

***these machines are intended for professional maintenance on golf courses, sports turf, and any other area maintained turf and related trails, paths and lots. No guaranty as to the suitability for any task is expressed or implied.***

**WEIGHTS AND DIMENSIONS**

Length	64" (163 cm)
Width	57" (145 cm)
Height	47" (119 cm)
Wheel Base	41" (104 cm)
Weight	950 lbs. ( 451 kg)

**SOUND LEVEL**

At Ear Level	85 dB
At 3ft (.914 m)	83 dB
At 30 ft (9.14 m)	73 dB

**ENGINE**

Make	Briggs and Stratton Vanguard
Model#	303447
Type / Spec#	1131E1
Horsepower	16 hp (11.9 kW)
Fuel	Unleaded 87 Octane Gasoline Minimum
Cooling System	Air Cooled
Lubrication System	Full Pressure
Alternator	16 amp

**WHEELS & TIRE**

Three: 23 x 10.5 x 12; 4 ply multitrack 5 psi (.35 bar)  
 Front tire fluid filled to 80 lbs. total. 41.5 pints of windshield washer fluid or equivalent.

**Speed**

Forward Speed	0 to 11 m.p.h. (0-18 kph)
Reverse Speed	0 to 5 m.p.h. (0-8 kph)

**BATTERY**

	Automotive Type 45-12 Volt
BCI Group	Size 45
Cold Cranking Amps	480
Ground Terminal Polarity	Negative (-)
Maximum Length	9" (23 cm)
Maximum Width	5.38" (14 cm)
Maximum Height	9" (23 cm)

**FLUID CAPACITY**

Crankcase Oil	See Engine Manual
Fuel	20 quarts (18.93 liters)
Hydraulic Fluid	20 quarts (18.93 liters)
Grade of Hydraulic Fluid	SAE 10W-40 API Service SJ or higher Motor Oil

# SPECIFICATION GAS AND DIESEL SUPER RAKE

WEIGHTS AND DIMENSIONS	GAS SUPER RAKE	DIESEL SUPER RAKE
Length	85" (216 cm)	85" (216 cm)
Width	73.5" (187 cm)	73.5" (187 cm)
Height	45" (114 cm)	45" (114 cm)
Wheel Base	47" (120 cm)	47" (120 cm)
Weight	990 lbs (449 kg)	1010 lbs (458 kg)
<b>SOUND LEVEL</b>		
At ear level	84 dB	96 dB
At 3 ft. (0.914 m)	89 dB	90 dB
At 30 ft. (9.14 m)	74 dB	78 dB
<b>ENGINE</b>		
Make	Briggs and Stratton Vanguard	Kubota
Model#	303447	Z482b
Type / Spec #	1018A2	
Horsepower	16 hp (12 kW)	12.5 hp (9.5 kW)
Fuel	Unleaded 85 Octane (min)	No. 2 Diesel
Cooling System	Air Cooled	Liquid Cooled
Lubrication System	Pressure Type	Full Pressure
Alternator	16 AMP	12.5 AMP
<b>SPEED</b>		
Forward Speed	0 to 10 m.p.h. (0-16 kph)	0 to 10 m.p.h. (0-16 kph)
Reverse Speed	0 to 4 m.p.h. (0-6 kph)	0 to 4 m.p.h. (0-6 kph)
<b>TIRES &amp; WHEELS</b>		
All Tires	** (3) 21 x 11.00 x 8 NHS 5 psi (.35 bar)	** (3) 21 x 11.00 x 8 NHS 5 psi (.35 bar)
<b>BATTERY</b>		
	Automotive Type 45-12 Volt	Automotive Type 45-12 Volt
BCI Group	Size 45	Size 45
Cold Cranking Amps	480	480
Ground Terminal Polarity	Negative (-)	Negative (-)
Maximum Length	9" (23 cm)	9" (23 cm)
Maximum Width	5.38" (14 cm)	5.38" (14 cm)
Maximum Height	9" (23 cm)	9" (23 cm)
<b>FLUID CAPACITY</b>		
Crankcase Oil	See Engine Manual	See Engine Manual
Fuel	15.6 quarts (14.8 liters)	15.6 quarts (14.8 liters)
Hydraulic Fluid	12.9 quarts (12.2 liters)	12.9 quarts (12.2 liters)
Grade of Hydraulic Fluid	SAE 10W-40 API Service SJ or Higher Motor Oil	SAE 10W-40 API Service SJ or Higher Motor Oil

\*\* Front tire fluid filled to 60 lbs. (27.22 kg) total.  
34.5 pints (16.33 l) of windshield washer fluid or equivalent.



The Bunker Rakes arrive from **SMITHCO** with some assembly required before service.

1. Set park brake. Push the brake down past center and the park brake is engaged.
2. Rear wheel mounting. Block front tire. Jack up rear of machine being careful not to damage underside of machine. Place wheel on hub lining up bolt holes. Use the ten lug nuts provided. Then torque to 64 - 74 ft/lb (87-100 Nm) using a cross pattern. Retorque after the first 10 hours and every 200 hours thereafter. Lower machine to ground and remove blocks and jack.
3. Install steering wheel (Ref 1) on machine. Put steering wheel onto shaft (Ref 3) Line up holes and insert 1/4 x 2" Roll Pin (Ref 2) into wheel shaft. Tighten set screw.
4. Check the tire pressure. The tire pressure should be 5 psi (0.35 bar)
5. Battery not furnished. Install an automotive type 45 -12 volt; 480 cold cranking amps (minimum) battery in the battery box of the Super Rakes and Super Stars This is a negative grounding system. Attach the battery hold-downs. Then attach red positive (+) cable (A) to positive terminal. Slide rubber boot over the positive terminal to prevent shorts. Attach black negative (-) cable (B) to the negative terminal.

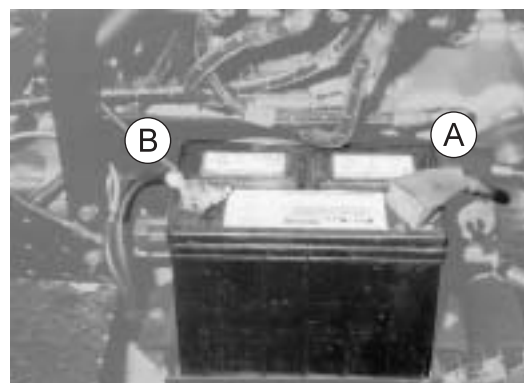
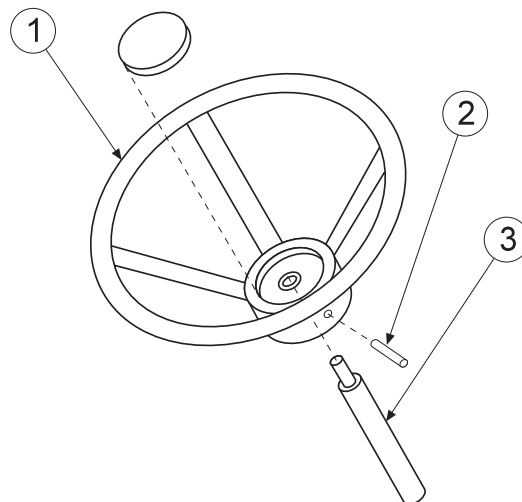

**Connecting battery cables to the wrong post could result in personal injury and/or damage to the electrical system. Make sure battery and cables do not interfere or rub on any moving part. Connect the red positive (+) cable (A) to the battery first. When disconnecting remove the black negative (-) cable (B) first.**

6. Check engine oil and add as necessary. See engine manual for recommended motor oil. **DO NOT OVER-FILL.**
7. Fill Gas Tanks with Unleaded 87 Octane gasoline (minimum).  
Fill Diesel Tanks with Diesel No. 2.



**Gasoline is flammable. Caution must be used when storing or handling it. Do not fill fuel tank while engine is operating or in an enclosed area. Fumes are explosive and dangerous to inhale. DO NOT SMOKE while filling the fuel tank. DO NOT OVERFILL.**

8. Check hydraulic oil level on the tank. The level should be 2 -2 1/2" (5 - 6.35 cm) from top of tank. If level is low, add SAE 10W-40 API Service SJ or higher motor oil.
9. Machine should be greased before starting.
10. Read operating instructions before starting machine.

## CONTROLS & INSTRUMENTS GAS SUPER RAKE

### INSTRUMENT PANEL

Located on right fender.

- A. **Ignition Switch:** Three Position. Stop-Run-Start.
- B. **Two Or Three Wheel Drive:** Front wheel drive valve is located on front right fender. Push to engage front wheel drive and pull to disengage front wheel drive.



**Disengage front wheel drive for transport and plow operation only. Three to two wheel drive can be shifted on the fly. Two wheel drive increases ground speed.**

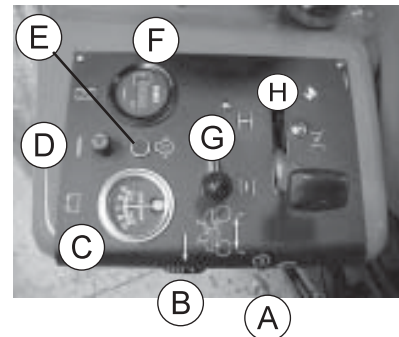

- C. **Ammeter:** The ammeter indicates the rate of charging or discharging of battery.
- D. **Fuse Holder and Fuse:** Located in center right side of instrument panel. A 30 Amp fuse is used.
- E. **Oil Light:** The oil light should come on when ignition is on, without engine operating. The oil light will light when the oil pressure is low. If oil light should come on, shut off engine immediately and find cause.
- F. **Hour Meter:** The hour meter indicates hours of machine operation. The hour meter operates when ignition switch is on.
- G. **Choke:** Choke is located in center of instrument panel. Pull choke to rear to close choke plate when starting a cold engine. A warm engine may not require "choking" to start.
- H. **Hand Throttle:** Hand throttle is located on left side of instrument panel. Use it to regulate engine speed.

### RIGHT FLOORBOARD

Foot Pedal controls forward and reverse motion. Pushing down on the front of pedal (I) will give you a forward motion and pushing down on rear pedal will give you a reverse motion. When pedal is released the hydrostatic transmission centers and stops the vehicle. Ground speed is proportional to how far the foot pedal is depressed. (I) is the Hand Lift for the Sand Plow.



**Quick removal of foot from forward or reverse pedal will result in an abrupt stop of machine.**



### STEERING

The automotive type steering wheel is connected to the front wheel assembly by a chain driven sprocket. This allows for quick turns and short turning radius.

### SEAT ADJUSTMENT

Seat Adjustment Lever is located under front of seat on left side. It allows seat adjustment forward or backward for operator's comfort. There are four different bolt patterns so that you can manually adjust seat to fit operator's comfort.

### PARK BRAKE

Park brake is located on left fender. Push lever (K) forward to release brake and pull lever rearward to set brake. Park brake must be applied to start trap rake.

### VALVE PANEL

The Lift Levers are located on left fender. To raise push down and to lower pull back forward. Release the lever when attachment is in proper position and lever will return too neutral. The Rake Lift lever (L) is on the inside of the machine. The Lift Assembly lever (M) is on the outside closest to the seat unless equipped with a hydraulic plow then the plow lever is closest to the seat.

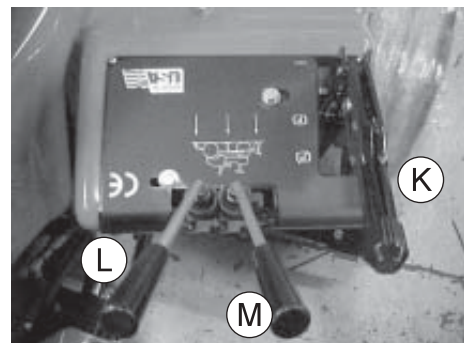

## CONTROLS & INSTRUMENTS DIESEL SUPERRAKE

### INSTRUMENT PANEL

Located on right fender.

- A. **Ignition Switch:** Four Position. Preheat-Stop-Run-Start.
- B. **Hour Meter:** The hour meter indicates the hours of machine operation. It operates only when the ignition switch is on. The volt meter indicates battery voltage.



**Disengage front wheel drive for transport and plow operation only. Three to two wheel drive can be shifted on the fly. Two wheel drive increases ground speed.**

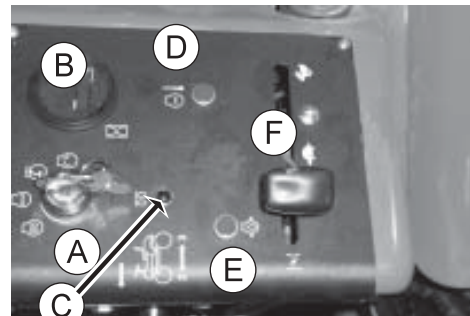

- C. **Glow Plug:** When ignition is turned to preheat, glow plug lights when ready to start.
- D. **Temperature Light:** The temperature light will come on if machine starts or over heat.
- E. **Oil Light:** The oil light should come on when ignition is on, without engine operating. The oil light will light when the oil pressure is low. If oil light should come on, shut off engine immediately and find cause.
- F. **Hand Throttle:** Hand throttle is located on right fender. Use it to regulate engine speed.

**Two Or Three Wheel Drive:** Front wheel drive valve is located on front right fender. Push to engage front wheel drive and pull to disengage front wheel drive.

### RIGHT FLOORBOARD

**Two Pedal Foot Control:** Foot Pedal controls forward and reverse motion and also acts as a brake. Pushing down on front pedal (J) will give you a forward motion and pushing down on rear pedal (K) will give you a reverse motion. When pedal is released the hydrostatic transmission centers and stops the vehicle with a braking action. Ground speed is proportional to how far the foot pedal is depressed.



**Quick removal of foot from forward or reverse pedal will result in an abrupt stop of machine.**

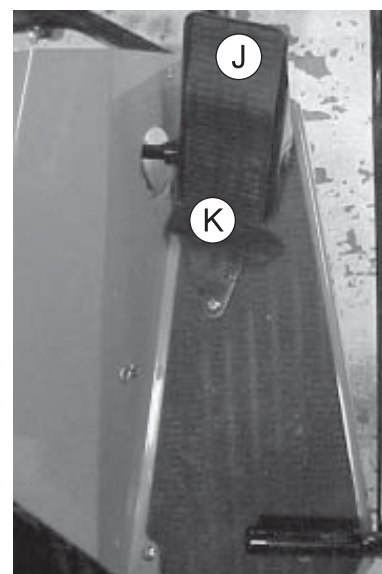

### STEERING

Acquaint yourself with steering before operating machine. The automotive type steering wheel is connected to the front wheel assembly by a chain driven sprocket. This allows for quick turns and short turning radius.

### SEAT ADJUSTMENT

Seat Adjustment Lever is located under front of seat on left side. It allows seat adjustment forward or backward for operator's comfort. There are four different bolt patterns so that you can manually adjust seat to fit operator's comfort.

### PARK BRAKE

Park brake is located on left fender. Push lever (I) forward to release brake and pull lever rearward to set brake. Park brake must be applied to start trap rake.

### VALVE PANEL

The Lift Levers are located on left fender. To raise push down and to lower pull back forward. Release the lever when attachment is in proper position and lever will return to neutral. The Rake Lift lever (L) is on the inside of the machine. The Lift Assembly lever (M) is on the outside closest to the seat unless equipped with a hydraulic plow then the plow lever is closest to the seat.

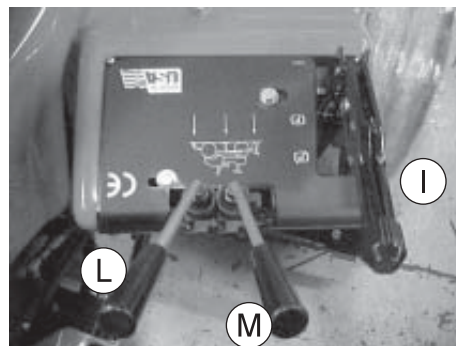

## CONTROLS & INSTRUMENTS SUPER STAR

### INSTRUMENTS LOCATED ON THE CONTROL PANEL

- A. **Electric On/Off Valve Switch** - Toggle switch that turns 2 Wheel to 3 Wheel Drive. For 42-117 Optional Electric Valve Kit.
- B. **Oil Light** - The oil light should come on when ignition is on without engine operating. The oil light will light when the oil pressure is low. If oil light should come on, shut off engine immediately and find the cause.
- C. **Ignition Switch** - The ignition switch has three positions: Off-Run-Start.
- D. **Choke** - Pull choke control knob up to close choke plate when starting a cold engine. A warm engine may not require "choking" to start.
- E. **Hand Throttle** - The hand throttle is used to regulate engine speed.
- F. **Blower** - This is an optional switch that comes with the Leaf and Debris Blower.
- G. **Light** - this is an optional switch that comes with the Light Kit.

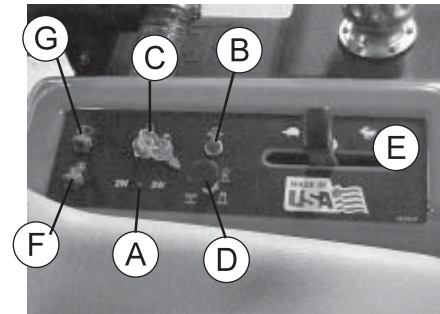

### STEERING

Acquaint yourself with the steering before operating the machine. This machine is equipped with a tilt steering mechanism. The lever to tilt the steering wheel is located at bottom of rubber boot on steering column. Hold the lever down and adjust the steering wheel to a comfortable position.

### RAKE LIFT LEVER

This lever (H) raises and lowers all rear attachments. To raise push forward, to lower pull back. Release the lever when attachment is in proper position and lever will return to neutral.

### LIFT ASSEMBLY LEVER

This lever (J) raises and lowers all attachments under the center of the machine. To raise push forward, to lower pull back. Release the lever when attachment is in proper position and lever will return to neutral.

### SEAT ADJUSTMENT

Seat adjustment lever is located under front of seat on left side. It allows seat adjustment forward or backward for operator's comfort. The seat also has the start safety switch in it. To start the Super Star the operator must be sitting on the seat.

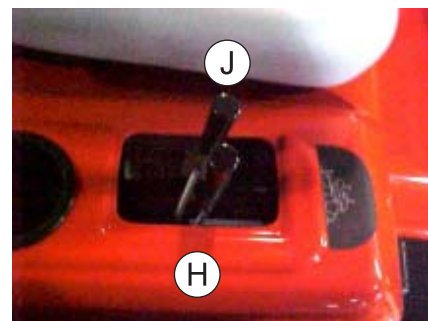

### RIGHT FLOORBOARD

Foot Pedal controls forward and reverse motion. Pushing down on the front of pedal (K) will give you a forward motion and pushing down on rear pedal (L) will give you a reverse motion. When pedal is released the hydrostatic transmission centers and stops the vehicle. Ground speed is proportional to how far the foot pedal is depressed.

### HOUR METER/ VOLT METER

Located on the right front fiberglass cowling (M). The hour meter indicates hours of machine operation. The hour meter operates when ignition switch is on. The volt meter indicates battery voltage. When starting the battery, voltage should not drop below 9 volts, with the key on, engine not operating the voltage should be 12 volts. With engine operating at 3600 rpm the voltage should read around 14 volts.

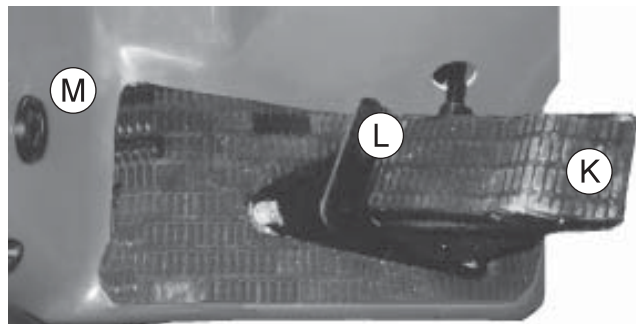

## STARTING ENGINE

Before operating this machine, become familiar with all controls and functions of these units. Also complete all maintenance requirements and read all safety warnings. By knowing the machine thoroughly, how it operates and by doing the prescribed maintenance steps, you can expect relatively trouble-free operation for years to come.

1. Make sure the fuel flow valve, located on the fuel tank, is "ON."
2. Set park brake. Start safety switch is on the park brake.
3. The ignition switch is a three position on gas and four position on diesel. For Gas engines: Insert key (A) and turn clockwise until engine starts (C). Release key and it will return to run position (B). Use choke and hand throttle as necessary. For Diesel Engines: Insert key (A) and turn counterclockwise (D) until glow plug is glowing. Turn key clockwise until engine starts (C). Release key and it will return to run position (B).
4. Allow engine to idle and warm up a few minutes before selecting a direction of travel.
5. To shut off engine on all gas machines turn key to the stop position. On Diesel Super Rake move throttle to stop position and pull teh Kill control handle.

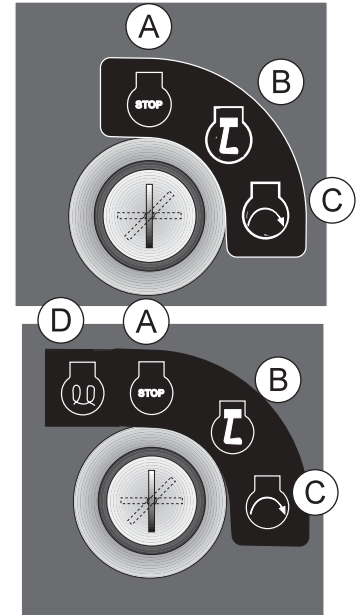

## COLD WEATHER STARTING

When attempting to start the engine in cold weather, the oil in the hydrostat pump may provide too much resistance to start a cold machine.

Before attempting to start the engine in cold weather, disengage the drive belt to the hydrostat by pushing down the idler lever until it catches in the notch on the latching lever. Start engine and allow it to warm up with no load. When the engine is warm, shut off engine. Push down on the latching lever until the idler is released.



**WARNING**

Engine must be stopped when the drive belt is engaged. If the engine is running when the belt is engaged, the vehicle may move suddenly, injuring you and/or bystanders.

**NOTE:**

Always stop the engine before reengaging the drive belt. The sudden application of power to the hydrostat may cause serious damage the pump, the engine or both.

## DAILY CHECKLIST

**NOTE:** Use all procedures and parts prescribed by the manufacturer's. Read the engine manual before operation.

The suggested maintenance checklist is not offered as a replacement for the manufacturer's but as a supplement. You must adhere to guidelines established by manufacturer for warranty coverage. In adverse conditions such as dirt, mud or extreme temperatures, maintenance should be more frequent.

### DAILY CHECKLIST

1. Check park brake adjustment. Adjust as required.
2. Check engine oil level. Add as needed. DO NOT OVERFILL.
3. Tire pressure should be 5 psi (0.35 bar) maximum.
4. Inspect electrical system for loose connections or frayed wiring, including battery cables. Replace any faulty equipment or tighten if loose.
5. Check hardware for loose or missing nuts, bolts, screws, etc., and tighten or replace as needed.
6. Inspect hydraulic lines for damage or leaks. Never use hands to inspect leaks.
7. Check hydraulic oil level on the tank. The level should be 2 -2<sup>1</sup>/<sub>2</sub>"(5 - 6.35 cm) from top of tank. If level is low, add SAE 10W-40 API Service SJ or higher motor oil.
8. Inspect steering, throttle and shift linkages for good hookups and clear travel.
9. Check anti-vibration mounts on engine frame.
10. Check controls for smooth, proper working operation. Lubricate as needed.
11. Remove debris from engine compartment

## HOW TO RAKE A SAND TRAP

### HOW TO RAKE A SAND TRAP

View bunker to determine the most efficient pattern to follow so that rake pattern and configuration of bunker will flow in same general direction and look attractive.

Enter bunker at its lowest point. Perhaps drain area or another point where “lip” of the trap is minimal.

Operate at 2-4 m.p.h. (3-6.5 kph) for best raking results. Control speed with hydraulic pedal.

Once fully inside bunker, lower rear rake and proceed forward as described above.

First pass should be directly down center of trap. This helps avoid extremely sharp turns that will spoil sands’ appearance.

Once at far end, turn machine and drive down one side of trap and come back up other side.

Grass or other material may build up on rake tines as machine passes “enter/exit” point in Figure 1. Lift rake briefly while still moving forward.

Do not rake closer than 6" (15 cm) to edge of trap.

Do not rake slopes in trap. The weight of machine will pull sand down.

Use cultivator or other center mounted accessories only as necessary for compacted sand. Frequent use will leave sand too soft and objectionable to some golfers.

Use front mounted plow to push sand to desired locations within trap.

After exiting trap, secure machines in accordance with practices described in this manual. Rake trap edges, slopes and “enter /exit” area with a hand rake.

After returning to maintenance area, thoroughly clean machine, check fluids, and lubricate as advised in this manual.

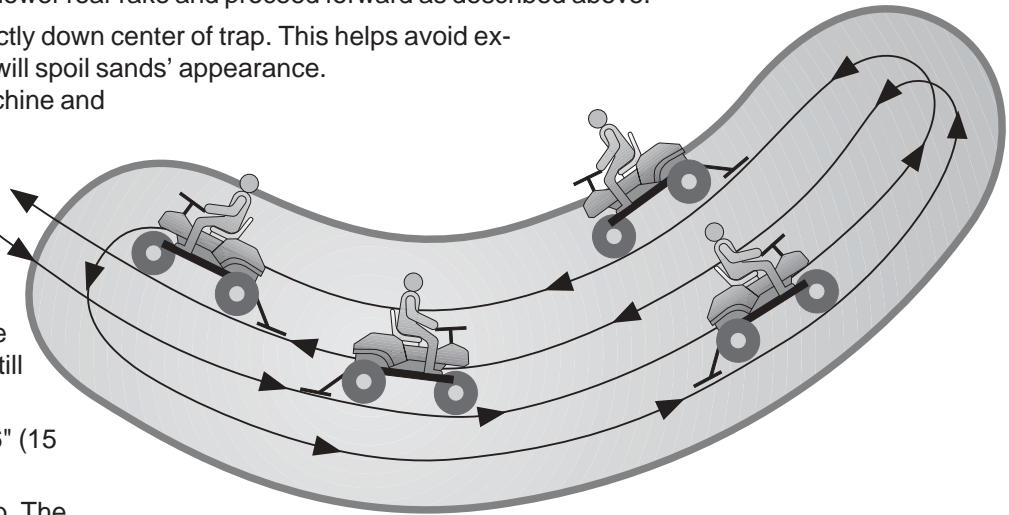

# BATTERY

## BATTERY

Batteries normally produce explosive gases which can cause personal injury. Do not allow flames, sparks or any ignited object to come near the battery. When charging or working near battery, always shield your eyes and always provide proper ventilation.

Battery cable should be disconnected before using "Fast Charge".

Charge battery at 15 amps for 10 minutes or 7 amps for 30 minutes. Do not exceed the recommended charging rate. If electrolyte starts boiling over, decrease charging.

Always remove grounded (-) battery clamp first and replace it last. Avoid hazards by:

1. Filling batteries in well-ventilated areas.
2. Wear eye protection and rubber gloves.
3. Avoid breathing fumes when electrolyte is added.
4. Avoid spilling or dripping electrolyte.



**WARNING**

**Battery Electrolyte is an acidic solution and should be handled with care. If electrolyte is splashed on any part of your body, flush all contact areas immediately with liberal amounts of water. Get medical attention immediately.**

## JUMP STARTING



**WARNING**

**Use of booster battery and jumper cables. Particular care should be used when connecting a booster battery. Use proper polarity in order to prevent sparks.**

To jump start (negative grounded battery):

1. Shield eyes.
2. Connect ends of one cable to positive (+) terminals of each battery, first (A) then (B).
3. Connect one end of other cable to negative (-) terminal of "good" battery (C).
4. Connect other end of cable (D) to engine block on unit being started (NOT to negative (-) terminal of battery)

To prevent damage to other electrical components on unit being started, make certain that engine is at idle speed before disconnecting jumper cables.

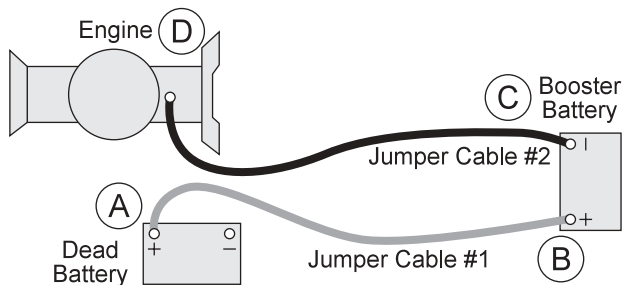

**EC Declaration of Conformity**  
according to Directive 89/392/EEC

We

**SMITHCO INC.**

*(Name of supplier)*

**34 West Ave. Wayne, PA 19087 USA**

*(Full address of the manufacture - authorized representative established in the Community must also give the business name and address of the manufacture)*

declare under our sole responsibility, that the product

**Gas Super Rake 13-550-D/13-551-D  
Diesel Super Rake 17-001-E  
Super Star 42-000-E/42-001-D**

*(Make, Model)*

to which this declaration relates corresponds to the relevant basic safety and health requirements of the Directive 89/392/EEC,

*(if applicable)*

and to the requirements of the other Directives:

**EN292-1**

**EN292-2**

**EN294**

**EN349**

**92/59**

**89/392**

*(Title and/or number and date of issue of the other Directives)*

*(if applicable)*

For the relevant implementation of the safety and health requirements mentioned in the Directives, the following standard(s) and/or technical specification(s) has (have) been respected:

**ISO 37-1983**

**PREN 836**

**ISO 1219-1976**

**SAE HS-2800**

**SAE J1362**

*(Title and/or number and date of issue of standard(s) and/or technical specification(s))*

**Cameron, Wisconsin USA**

**March 19, 1995**

*(Place and date of issue)*

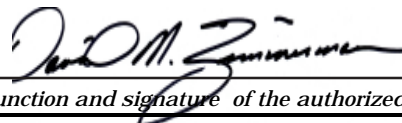

*(Name, function and signature of the authorized person)*



## LIMITED WARRANTY

SMITHCO warrants this product to be free from defects in material and workmanship under normal use for one year from the date of purchase by the original user. (60 days if product is used for rental purposes.) All warranty claims must be handled through a SMITHCO authorized dealer or by SMITHCO, INC. All transportation charges must be paid by the purchaser.

There is no further express warranty. All implied warranties, including those of merchantability and fitness for a particular purpose, are limited to one year, (60 days if product is used for rental purposes) from the date of purchase by the original user, and to the extent permitted by law any and all implied warranties are excluded and disclaimed after the expiration of such period.

All incidental and consequential damages, including pickup and delivery of the unit, communication, mileage charges and/or rental of a replacement unit during repair, are not covered under this warranty, nor is any loss of income and/or other loss resulting from the failure of the product to function due to a warranty defect.

The following items are not covered under the SMITHCO warranty, and are warranted by their respective manufacturer.

- (a) Engine and engine parts, including starters, generators, alternators and filters.
- (b) Transaxle, differentials, gear boxes and mechanical pumps.
- (c) Hydrostatic transmissions, hydraulic pumps and motors.
- (d) Batteries.
- (e) Wheels and tires.

A copy of the warranty for the above items is furnished if necessary with each SMITHCO product.

Some states do not allow limitations on how long an implied warranty lasts, or the exclusion or limitations of incidental or consequential damages, so the above limitations or exclusions may not apply to you. This warranty gives you specific legal rights and you may also have other rights, which may vary from state to state.

Federal law now requires disclosure of the warranty which applies to this product prior to the sale to a customer. Please leave this statement attached to the product and allow the buyer to remove it after purchase.

**SMITHCO**

Wayne, Pennsylvania 19087

