

Operator's



*Super Star LE*  
42-400-A

*June 2009*

**Product Support:**

**Hwy 55 & Poplar Ave; Cameron WI 54822**

**1-800-891-9435    productsupport@smithco.com**

# CONTENTS

Introduction

Service

Diagrams

<b>Introduction .....</b>	<b>1-12</b>
Introduction .....	1
Symbols .....	2-3
Safe Practices .....	4
Super Star Diesel Specifications .....	5
Euro Star Specifications .....	6
Setup .....	7
Controls & Instruments Euro Star .....	8
Controls & Instruments Super Star Diesel .....	9
Operation .....	10
Daily Checklist .....	11
How To Rake A Sand Trap .....	12
<b>Service .....</b>	<b>13</b>
Battery .....	13
<b>Other .....</b>	<b>14</b>
Declaration of Conformity .....	14
Limited Warranty .....	Inside Back Cover

Thank you for purchasing a **Smithco** product.

Read this manual and all other manuals pertaining to the Bunker Rake carefully as they contain safety, operating, assembly and maintenance instructions. Failure to do so could result in personal injury or equipment damage.

Keep manuals in a safe place after operator and maintenance personnel have read them. Right and left sides are from the operator's seat, facing forward.

All **Smithco** machines have a Serial Number and Model Number. Both numbers are needed when ordering parts. Refer to engine manual for placement of engine serial number.

The serial number plate on the Super Rakes is located on the right side main frame.

The serial number plate for the Super Star is located on the rear axle.











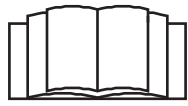



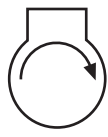
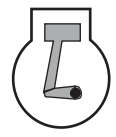
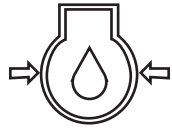

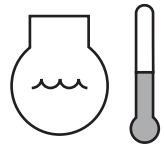
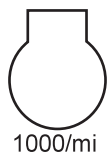
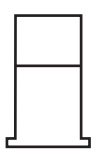
For easy access record your Serial and Model numbers here.



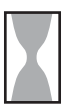
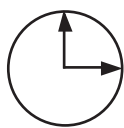
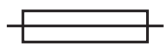

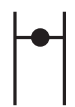



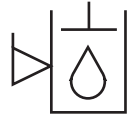

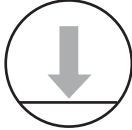

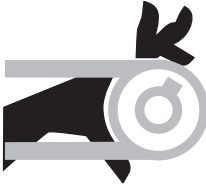

<b>SMITHCO</b>		DATE OF MFG.
WAYNE, PENNSYLVANIA 19087 USA 610-688-4009 Fax 610-688-6069		<input type="text"/>
SERIAL NO.	<input type="text"/>	kW/hp <input type="text"/>
MODEL NO.	<input type="text"/>	kg/lb <input type="text"/>

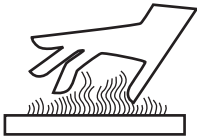
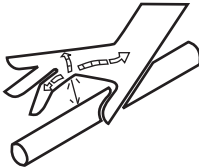
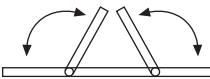
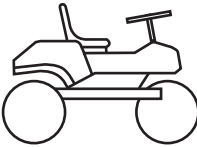
Information needed when ordering replacement parts:

1. Model Number of machine
2. Serial Number of machine
3. Name and Part Number of part
4. Quantity of parts

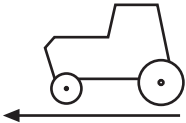
# SYMBOLS

	Read Operator's Manual		Electrical Power		No Electrical Power
	Engine - Stop		Engine - Start		Engine - Run
	Engine Oil		Temperature Light		Water Temperature
	RPM		Gasoline		Diesel
	Glow Plug - On		Glow Plug - Off		Glow Plug
	Hour Meter		Hour Meter		Fuse
	Hand Throttle		Choke - Closed		Choke - Open
	Park Brake		Park Brake Release		Hydraulic Oil Level

	Up/Down Arrow		Down/Lower		Up/Raise
	No Smoking		Moving Parts		Manual Operation
	Pinch Point		Step		Hot Surface
	Hydraulic Fluid Penetration		Lift Arm		Tractor
	Engage		Disengage		PTO
	Ground Speed		Fast		Slow
<b>H</b>	High	<b>L</b>	Low	<b>F</b>	Forward
<b>R</b>	Reverse	<b>N</b>	Neutral		Warning Danger Caution

## SAFE PRACTICES

1. It is your responsibility to read this manual and all publications associated with this machine (engine, accessories and attachments).
2. Never allow anyone to operate or service the machine or its attachments without proper training and instructions. Never allow minors to operate any equipment.
3. Learn the proper use of the machine, the location and purpose of all the controls and gauges before you operate the equipment. Working with unfamiliar equipment can lead to accidents.
4. Wear all Personal Protective Equipment (PPE) on your head, eyes, ears, hands and feet. Operate the machine only in daylight or in good artificial light.
5. Inspect the area where the equipment will be used. Pick up all debris you can find before operating. Beware of overhead obstructions and underground obstacles. Stay alert for hidden hazards.
6. Never operate equipment that is not in perfect working order or without decals, guards, shields, or other protective devices in place.
7. Never disconnect or bypass any switch.
8. Carbon monoxide in the exhaust fumes can be fatal when inhaled, never operate a machine without proper ventilation.
9. Fuel is highly flammable, handle with care.
10. Keep engine clean. Allow the engine to cool before storing and always remove the ignition key.
11. After engine has started machine must not move. If movement is evident, the neutral mechanism is not adjusted correctly. Shut engine off and readjust so the machine does not move when in neutral position.
13. Never use your hands to search for oil leaks. Hydraulic fluid under pressure can penetrate the skin and cause serious injury.
14. This machine demands your attention. To prevent loss of control or tipping of the vehicle:
  - A. Use extra caution in backing up the vehicle. Ensure area is clear.
  - B. Do not stop or start suddenly on any slope.
  - C. Reduce speed on slopes and in sharp turns. Use caution when changing directions on slopes.
  - D. Stay alert for holes in the terrain and other hidden hazards.
15. Before leaving operator's position for any reason:
  - A. Disengage all drives.
  - B. Lower all attachments to the ground.
  - C. Set park brake.
  - D. Shut engine off and remove the ignition key.
16. Keep hands, feet and clothing away from moving parts. Wait for all movement to stop before you clean, adjust or service the machine.
17. Keep the area of operation clear of all bystanders.
18. Never carry passengers.
19. Stop engine before making repairs/adjustments or checking/adding oil to the crankcase.
20. Use parts and materials supplied by **Smithco** only. Do not modify any function or part.

***these machines are intended for professional maintenance on golf courses, sports turf, and any other area maintained turf and related trails, paths and lots. No guaranty as to the suitability for any task is expressed or implied.***

## SPECIFICATION SUPER STAR LE

### WEIGHTS AND DIMENSIONS

Length	64" (163 cm)
Width	57" (145 cm)
Height	47" (119 cm)
Wheel Base	51" (104 cm)
Weight	950 lbs. (451 kg)

### SOUND LEVEL

At ear level	85 dB
At 3 ft. (0.914 m)	83 dB
At 30 ft. (9.14 m)	73 dB

### ENGINE

Make	Briggs and Stratton Vanguard
Model#	303447
Type / Spec #	1131E1
Horsepower	16 hp (12 kW)
Fuel	Unleaded 87 Octane (min)
Cooling System	Air Cooled
Lubrication System	Pressure Type
Alternator	16 AMP

### SPEED

Forward Speed	0 to 11 m.p.h. (0-18 kph)
Reverse Speed	0 to 5 m.p.h. (0-8 kph)

### TIRES & WHEELS

All Tires	**Three 22 x 11 x 10.00 Knobby Tires 8 psi (.55 bar)
-----------	---

### BATTERY

	Automotive Type 45-12 Volt
BCI Group	Size 45
Cold Cranking Amps	480
Ground Terminal Polarity	Negative (-)
Maximum Length	9" (23 cm)
Maximum Width	5.38" (14 cm)
Maximum Height	9" (23 cm)

### FLUID CAPACITY

Crankcase Oil	See Engine Manual
Fuel	20 quarts (19 liters)
Hydraulic Fluid	20 quarts (19 liters)
Grade of Hydraulic Fluid	SAE 10W-40 API Service SJ or Higher Motor Oil

\*\* Front tire fluid filled to 80 lbs. (36 kg) total.  
45.5 pints of windshield washer fluid or equivalent.

## SETUP

The Bunker Rakes arrive from **Smithco** with some assembly required before service.

1. Set park brake. Push the brake down past center and the park brake is engaged.
2. Rear wheel mounting. Block front tire. Jack up rear of machine being careful not to damage underside of machine. Place wheel on hub lining up bolt holes. Use the ten lug nuts provided. Then torque to 64 - 74 ft/lb (87-100 Nm) using a cross pattern. Retorque after the first 10 hours and every 200 hours thereafter. Lower machine to ground and remove blocks and jack.
3. Install steering wheel (Ref 1) on machine. Put steering wheel onto shaft (Ref 3) Line up holes and insert  $\frac{1}{4} \times 2"$  Roll Pin (Ref 2) into wheel shaft. Tighten set screw.
4. Check the tire pressure. The tire pressure should be 8 psi (0.55 bar)
5. Battery not furnished. Install an automotive type 45 - 12 volt; 480 cold cranking amps (minimum) battery in the battery box of the Super Star. This is a negative grounding system. Attach the battery hold-downs. Then attach red positive (+) cable (A) to positive terminal. Slide rubber boot over the positive terminal to prevent shorts. Attach black negative (-) cable (B) to the negative terminal.

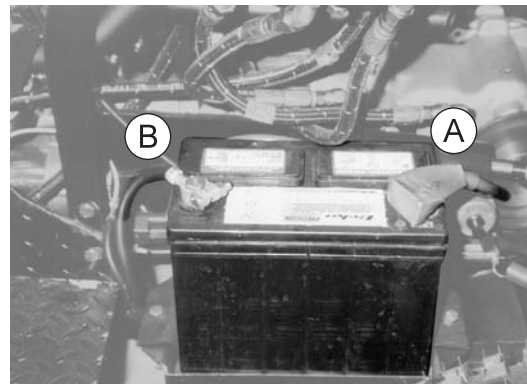
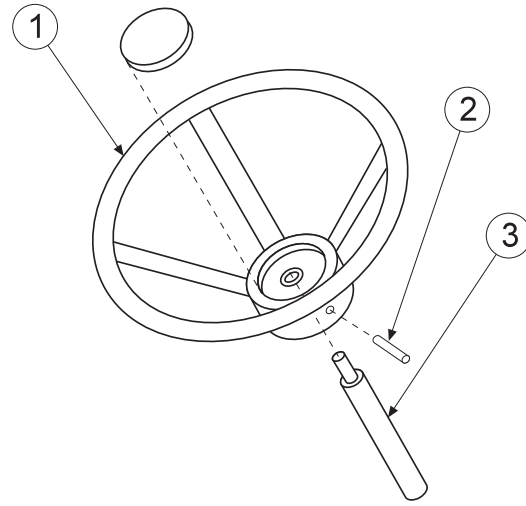

**Connecting battery cables to the wrong post could result in personal injury and/or damage to the electrical system. Make sure battery and cables do not interfere or rub on any moving part. Connect the red positive (+) cable (A) to the battery first. When disconnecting remove the black negative (-) cable (B) first.**

6. Check engine oil and add as necessary. See engine manual for recommended motor oil. **DO NOT OVERFILL.**
7. Fill Gas Tanks with Unleaded 87 Octane gasoline (minimum).



**Fuel is flammable. Caution must be used when storing or handling it. Do not fill fuel tank while engine is operating or in an enclosed area. Fumes are explosive and dangerous to inhale. DO NOT SMOKE while filling the fuel tank. DO NOT OVERFILL.**

8. Check hydraulic oil level on the tank. The level should be 2 - 2 $\frac{1}{2}$ " (5 - 6.35 cm) from top of tank. If level is low, add SAE 10W-40 API Service SJ or higher motor oil.
9. Machine should be greased before starting.
10. Read operating instructions before starting machine.

## INSTRUMENTS LOCATED ON THE CONTROL PANEL

- A. **Electric On/Off Valve Switch** - Toggle switch that turns 2 Wheel to 3 Wheel Drive. For 42-117 **Optional** Electric Valve Kit.
- B. **Oil Light** - The oil light should come on when ignition is on without engine operating. The oil light will light when the oil pressure is low. If oil light should come on, shut off engine immediately and find the cause.
- C. **Ignition Switch** - The ignition switch has three positions: Off-Run-Start.
- D. **Choke** - Pull choke control knob up to close choke plate when starting a cold engine. A warm engine may not require "choking" to start.
- E. **Hand Throttle** - The hand throttle is used to regulate engine speed.
- F. **Blower** - This is an **optional** switch that comes with the Leaf and Debris Blower.
- G. **Light** - This is an **optional** switch that comes with the Light Kit.

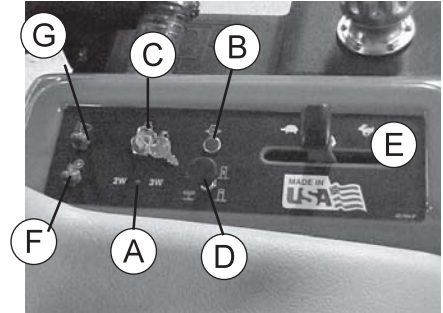

## STEERING

Acquaint yourself with the steering before operating the machine. This machine is equipped with a tilt steering mechanism. The lever to tilt the steering wheel is located at bottom of rubber boot on steering column. Hold the lever down and adjust the steering wheel to a comfortable position.

## RAKE LIFT LEVER

This lever (H) raises and lowers all rear attachments. To raise push forward, to lower pull back. Release the lever when attachment is in proper position and lever will return to neutral.

## LIFT ASSEMBLY LEVER

This lever (J) raises and lowers all attachments under the center of the machine. To raise push forward, to lower pull back. Release the lever when attachment is in proper position and lever will return to neutral.

## SEAT ADJUSTMENT

Seat adjustment lever is located under front of seat on left side. It allows seat adjustment forward or backward for operator's comfort. The seat also has the start safety switch in it. To start the Super Star the operator must be sitting on the seat.

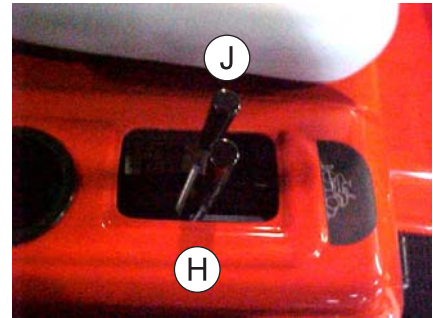

## RIGHT FLOORBOARD

Foot Pedal controls forward and reverse motion. Pushing down on the front of pedal (K) will give you a forward motion and pushing down on rear pedal (L) will give you a reverse motion. When pedal is released the hydrostatic transmission centers and stops the vehicle. Ground speed is proportional to how far the foot pedal is depressed.

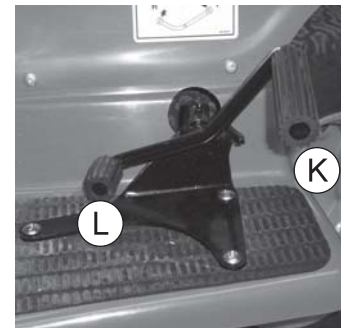

## HOURLY METER

Located on the right front fiberglass cowling. The hour meter indicates hours of machine operation. The hour meter operates when ignition switch is on.

## OPERATION AND DAILY CHECK LIST

### STARTING ENGINE

Before operating this machine, become familiar with all controls and functions of these units. Also complete all maintenance requirements and read all safety warnings. By knowing the machine thoroughly, how it operates and by doing the prescribed maintenance steps, you can expect relatively trouble-free operation for years to come.

1. Make sure the fuel flow valve, located on the fuel tank, is "ON."
2. Set park brake. Start safety switch is on the park brake.
3. The ignition switch is a three position. Insert key (A) and turn clockwise until engine starts (C). Release key and it will return to run position (B). Use choke and hand throttle as necessary.
4. Allow engine to idle and warm up a few minutes before selecting a direction of travel.
5. To shut off engine on all gas machines turn key to the stop position.

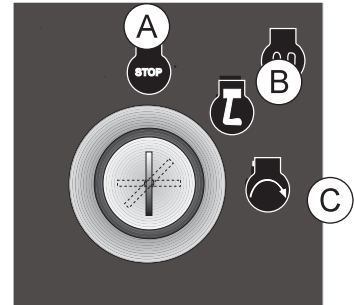

### COLD WEATHER STARTING

When attempting to start the engine in cold weather, the oil in the hydrostat pump may provide too much resistance to start a cold machine.

Before attempting to start the engine in cold weather, disengage the drive belt to the hydrostat by pushing down the idler lever until it catches in the notch on the latching lever. Start engine and allow it to warm up with no load. When the engine is warm, shut off engine. Push down on the latching lever until the idler is released.

Engine must be stopped when the drive belt is engaged. If the engine is running when the belt is engaged, the vehicle may move suddenly, injuring you and/or bystanders.

Always stop the engine before reengaging the drive belt. The sudden application of power to the hydrostat may cause serious damage to the pump, the engine or both.



**NOTE:**

**NOTE:** Use all procedures and parts prescribed by the manufacturer's. Read the engine manual before operation.

The suggested maintenance checklist is not offered as a replacement for the manufacturer's but as a supplement. You must adhere to guidelines established by manufacturer for warranty coverage. In adverse conditions such as dirt, mud or extreme temperatures, maintenance should be more frequent.

#### DAILY CHECKLIST

1. Check park brake adjustment. Adjust as required.
2. Check engine oil level. Add as needed. DO NOT OVERFILL.
3. Tire pressure should be 8 psi (0.55 bar) maximum.
4. Inspect electrical system for loose connections or frayed wiring, including battery cables. Replace any faulty equipment or tighten if loose.
5. Check hardware for loose or missing nuts, bolts, screws, etc., and tighten or replace as needed.
6. Inspect hydraulic lines for damage or leaks. Never use hands to inspect leaks.
7. Check hydraulic oil level on the tank. The level should be 2 -2<sup>1</sup>/<sub>2</sub>"(5 - 6.35 cm) from top of tank. If level is low, add SAE 10W-40 API Service SJ or higher motor oil.
8. Inspect steering, throttle and shift linkages for good hookups and clear travel.
9. Check anti-vibration mounts on engine frame.
10. Check controls for smooth, proper working operation. Lubricate as needed.
11. Remove debris from engine compartment



## HOW TO RAKE A SAND TRAP

### HOW TO RAKE A SAND TRAP

View bunker to determine the most efficient pattern to follow so that rake pattern and configuration of bunker will flow in same general direction and look attractive.

Enter bunker at its lowest point. Perhaps drain area or another point where “lip” of the trap is minimal.

Operate at 2-4 m.p.h. (3-6.5 kph) for best raking results. Control speed with hydraulic pedal.

Once fully inside bunker, lower rear rake and proceed forward as described above.

First pass should be directly down center of trap. This helps avoid extremely sharp turns that will spoil sands’ appearance.

Once at far end, turn machine and drive down one side of trap and come back up other side.

Grass or other material may build up on rake tines as machine passes “enter/exit” point in Figure 1. Lift rake briefly while still moving forward.

Do not rake closer than 6" (15 cm) to edge of trap.

Do not rake slopes in trap. The weight of machine will pull sand down.

Use cultivator or other center mounted accessories only as necessary for compacted sand. Frequent use will leave sand too soft and objectionable to some golfers.

Use front mounted plow to push sand to desired locations within trap.

After exiting trap, secure machines in accordance with practices described in this manual. Rake trap edges, slopes and “enter /exit” area with a hand rake.

After returning to maintenance area, thoroughly clean machine, check fluids, and lubricate as advised in this manual.

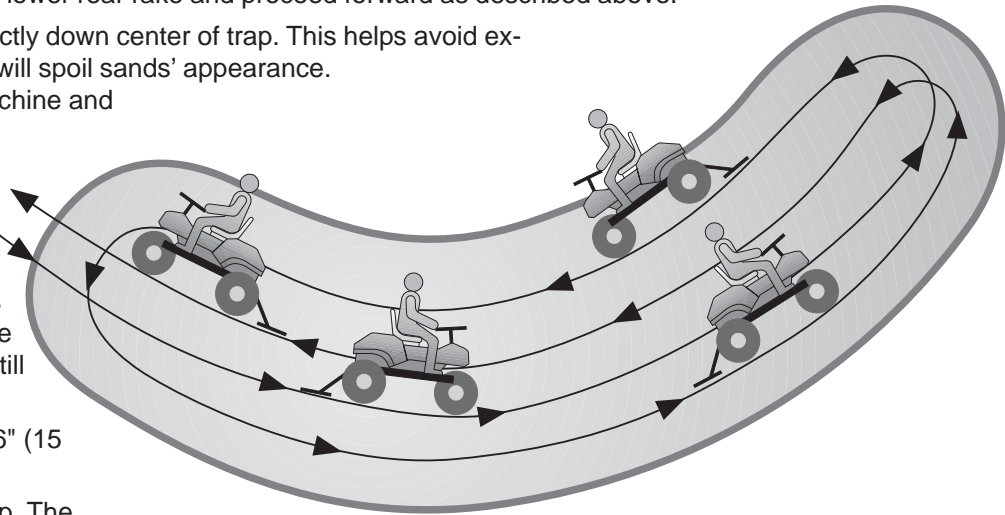

## BATTERY

Batteries normally produce explosive gases which can cause personal injury. Do not allow flames, sparks or any ignited object to come near the battery. When charging or working near battery, always shield your eyes and always provide proper ventilation.

Battery cable should be disconnected before using "Fast Charge".

Charge battery at 15 amps for 10 minutes or 7 amps for 30 minutes. Do not exceed the recommended charging rate. If electrolyte starts boiling over, decrease charging.

Always remove grounded (-) battery clamp first and replace it last. Avoid hazards by:

1. Filling batteries in well-ventilated areas.
2. Wear eye protection and rubber gloves.
3. Avoid breathing fumes when electrolyte is added.
4. Avoid spilling or dripping electrolyte.



**Battery Electrolyte is an acidic solution and should be handled with care. If electrolyte is splashed on any part of your body, flush all contact areas immediately with liberal amounts of water. Get medical attention immediately.**

## JUMP STARTING



**Use of booster battery and jumper cables. Particular care should be used when connecting a booster battery. Use proper polarity in order to prevent sparks.**

To jump start (negative grounded battery):

1. Shield eyes.
2. Connect ends of one cable to positive (+) terminals of each battery, first (A) then (B).
3. Connect one end of other cable to negative (-) terminal of "good" battery (C).
4. Connect other end of cable (D) to engine block on unit being started (NOT to negative (-) terminal of battery)

To prevent damage to other electrical components on unit being started, make certain that engine is at idle speed before disconnecting jumper cables.

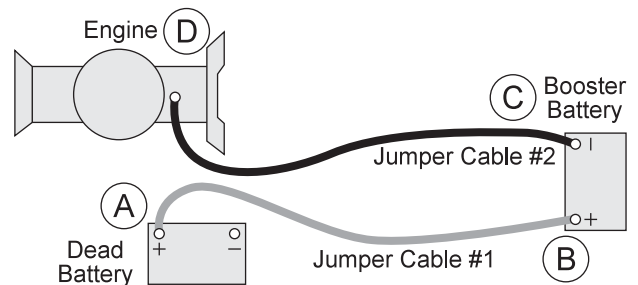

**DECLARATION OF CONFORMITY • ДЕКЛАРАЦИЯ ЗА СЪОТВЕТСТВИЕ • PROHLÁŠENÍ O SHODĚ • OVERENSSTEMMELSESERKLÆRING • CONFORMITEITSVERKLARING • VASTAVUSDEKLARATSIOON • VAATIMUSTENMUKAISUUSVAKUUTUS • DECLARATION DE CONFORMITE • KONFORMITÄTSEKTLÄRUNG • ΔΗΛΩΣΗ ΣΥΜΜΟΡΦΩΣΗΣ • MEGFELELŐSÉGI NYILATKOZAT • DICHIARAZIONE DI CONFORMITÀ • ATBILSTĪBAS DEKLARĀCIJA • ΑΤΙΤΙΚΤΙΕΣ ΔΕΚΛΑΡΑΚΙJA • DIKJARAZZJONI TAL-KONFORMITĀ • DEKLARACJA ZGODNOŚCI • DECLARAÇÃO DE CONFORMIDADE • DECLARAȚIE DE CONFORMITATE • VYHLÁŠENIE O ZHODE • IZJAVA O SKLADNOSTI • DECLARACIÓN DE CONFORMIDAD • DEKLARATION OM ÖVERENSSTÄMMELSE**

<p>Business name and full address of the manufacturer • Търговско име и пълен адрес на производителя • Obchodní jméno a plná adresa výrobce • Producentens firmanavn og fulde adresse • Bedrijfsnaam en volledig adres van de fabrikant • Tootja ärinimi ja täielik address • Valmistajan toiminimi ja täydellinen osoite • Nom commercial et adresse complète du fabricant • Firmenname und vollständige Adresse des Herstellers • Εταιρεία και ταχυδρομική διεύθυνση κατασκευαστή • A gyártó üzleti neve és teljes címe • Ragione sociale e indirizzo completo del fabbricante • Uzņēmuma nosaukums un pilna ražotāja adrese • Verslo pavadinimas ir pilnas gamintojo adresas • Isem kummerčjali u indirizs shh tal-fabrikant • Nazwa firmy i pełny adres producenta • Nome da empresa e endereço completo do fabricante • Denumirea comercială și adresa completă a producătorului • Obchodný názov a úplná adresa výrobcu • Naziv podjetja in polni naslov proizvajalca • Nombre de la empresa y dirección completa del fabricante • Tillverkarens företagsnamn och kompletta adress</p>	<p align="center"><b>Smithco Inc. 34 West Avenue Wayne, PA USA 19087-3311</b></p>
<p>Product Code • Код на продукта • Kód výrobku • Produktkode • Productcode • Toote kood • Tuotekoodi • Code produit • Produktcode • Κωδικός προϊόντος • Termékkód • Codice prodotto • Produkta kods • Produktokodas • Kódići tal-Prodott • Kod produktu • Código do Produto • Cod produs • Kód výrobku • Oznaka proizvoda • Código de producto • Produktkod</p>	<p align="center"><b>43-001-B</b></p>
<p>Machine Name • Наименование на машината • Název stroje • Maskinnavn • Machinenavn • Masina nimi • Laitteen nimi • Nom de la machine • Maschinenbezeichnung • Ονομασία μηχανήματος • Gépnev • Denominazione della macchina • Iekārtas nosaukums • Mašinos pavadinimas • Isem tal-Magna • Nazwa urządzenia • Nome da Máquina • Numele echipamentului • Názov stroja • Naziv stroja • Nombre de la máquina • Maskinens namn</p>	<p align="center"><b>Smithco Diesel Super Star</b></p>
<p>Designation • Предназначение • Označení • Betegnelse • Benaming • Nimetus • Tyypimerkintä • Pažymėjimas • Bezeichnung • Χαρακτηρισμός • Megnevezés • Funzione • Apzīmējums • Lithuanian • Denominazzjoni • Oznaczenie • Designação • Specificație • Označenie • Nomen stroja • Descripción • Beteckning</p>	<p align="center"><b>Bunker Rake</b></p>
<p>Serial Number • Серийн номер • Sériové číslo • Seriennummer • Seriennummer • Seerianumber • Valmistusnumero • Numéro de série • Seriennummer • Σειριακός αριθμός • Sorozatszám • Numero di serie • Sérijs numurs • Serijos numeris • Numru Serjali • Numer seryjny • Número de Série • Număr de serie • Sériové číslo • Serijska številka • Númer de serie • Seriennummer</p>	<p align="center"><b>14185</b></p>
<p>Engine • Двигател • Motor • Motor • Motor • Mootor • Mootori • Moteur • Motor • Μηχανή • Modulnė • Motore • Dzinējs • Variklis • Sahha Netta installata • Silnik • Motor • Motor • Motor • Motor • Motor • Motor</p>	<p align="center"><b>Briggs &amp; Stratton Diahatsu 850D</b></p>
<p>Net Installed Power • Нетна инсталирана мощност • Čistý instalovaný výkon • Installeret nettoeffekt • Netto ge installeerd vermogen • Installeeritud neto võimsus • Asennettu nettoteho • Puissance nominale nette • Installierte Nettoleistung • Καθαρή εγκατεστημένη ισχύς • Nettó beépített teljesítmény • Potenza netta installata • Paredzētā tīkla jauda • Grynoji galia • Wisa' tal-Qtugh • Moc zainstalowana netto • Pot ência instalada • Puterea instalată netă • Čistý inštalovaný výkon • Neto vgrajena moč • Potencia instalada neta • Nettoeffekt</p>	<p align="center"><b>18 kW</b></p>
<p>Conforms to Directives • В съответствие с директивите • Splňuje podmínky směrníc • Er i overensstemmelse med direktiver • Voldoet aan de richtlijnen • Vastab direktiivide • Direktiivien mukainen • Conforme aux directives • Entspricht Richtlinien • Ακολουθεί τις πιτά τις Οδηγίες • Megfelel az irányelveknek • Conforme alle Direttive • Atbilst direktīvām • Atitiktis direktīvų reikalavimus • Valutazzjoni tal-Konformità • Dyrektywy związane • Cumpre as Directivas • Respectă Directivele • Je v súlade so smernicami • Skladnost z direktivami • Cumple con las Directivas • Uppfyller direktiv</p>	<p align="center"><b>2006/42/EC; 2000/14/EC Annex VI - Part 1</b></p>
<p>Conformity Assessment • Оценка за съответствие • Hodnocení plnění podmínek • Overensstemmelsesvurdering • Conformiteitsbeoordeling • Vastavushindamine • Vaatimustenmukaisuuden arviointi • Evaluation de conformité • Konformitätsbeurteilung • Διαπίστωση Συμμόρφωσης • Megfelelőség-értékelés • Valutazione della conformità • Atbilstības novērtējums • Atitiktis ivertinimas • Livell tal-Qawwa tal-Foss Imkejjel • Ocena zgodności • Avaliação de Conformidade • Evaluarea conformității • Vyhodnotenie zhodnosti • Ocena skladnosti • Evaluación de conformidad • Bedömning av överensstämmelse</p>	<p align="center"><b>2006/42/EC Annex VIII</b></p>
<p>Measured Sound Power Level • Измерено ниво на звукова мощност • Naměřený akustický výkon • Målte lydstyrkeniveau • Gemeten geluidsniveau • Mõõdetud helivõimsuse tase • Mitattu äänitehotaso • Niveau de puissance sonore mesuré • Gemessener Schalldruckpegel • Σταθμισμένο επίπεδο ηχητικής ισχύος • Mért hangteljesítményszint • Livello di potenza sonora misurato • Izm ēritais skaņas jaudas līmenis • Išmatuotas garso stiprumo lygis • Livell tal-Qawwa tal-Foss Iggarranti • Moc akustyczna mierzona • Nivel sonoro medido • Nivelul măsurat al puterii acustice • Nameraná hladina akustického výkonu • Izmerjena raven zvočne moči • Nivel de potencia sonora medido • Uppmätt ljudeffektsnivå</p>	<p align="center"><b>94dB(A)Lwa</b></p>
<p>Guaranteed Sound Power Level • Гарантирано ниво на звукова мощност • Garantovaný akustický výkon • Garanteret lydstyrkeniveau • Gegarandeerd geluidsniveau • Garanteeritud helivõimsuse tase • Taattu äänitehotaso • Niveau de puissance sonore garanti • Garantierter Schalldruckpegel • Εγγυημένο επίπεδο ηχητικής ισχύος • Szavatolt hangteljesítményszint • Livello di potenza sonora garantito • Garant ėtais skaņas jaudas līmenis • Garantuotas garso stiprumo lygis • Livell tal-Qawwa tal-Foss Iggarranti • Moc akustyczna gwarantowana • Nivel sonoro garantido • Nivelul garantat al puterii acustice • Garantovaná hladina akustického výkonu • Zajamčena raven zvočne moči • Nivel de potencia sonora garantizado • Garanterad ljudeffektsnivå</p>	<p align="center"><b>95dB(A)Lwa</b></p>
<p>Conformity Assessment Procedure (Noise) • Оценка за съответствие на процедурата (Шум) • Postup hodnocení plnění podmínek (hluk) • Procedure for overensstemmelsesvurdering (Støj) • Procedure van de conformiteitsbeoordeling (geluid) • Vastavushindamismenetlus (müra) • Vaatimustenmukaisuuden arviointimenetely (Melu) • Procédure d'évaluation de conformité (bruit) • Konformitätsbeurteilungsverfahren (Geräusch) • Διαδικασία Αξιολόγησης Συμμόρφωσης (Θόρυβος) • Megfelelőség-értékelési eljárás (Zaj) • Procedura di valutazione della conformità (rumore) • Atbilstības novērtējuma procedūra (troksnis) • Atitiktis ivertinimo procedūra (garsas) • Procedura tal-Valutazzjoni tal-Konformità (Foss) • Procedura oceny zgodności (poziom hałas) • Processo de avaliação de conformidade (nivel sonoro) • Procedura de evaluar a conformității (zgomot) • Postup vyhodnocovania zhodnosti (hluk) • Postopek za ugotavljanje skladnosti (hrup) • Procedimiento de evaluación de conformidad (ruido) • Procedur för bedömning av överensstämmelse (buller)</p>	<p align="center"><b>2000/14/EC Annex VI Part 1</b></p>
<p>UK Notified Body for 2000/14/EC • Нотифициран орган в Обединеното кралство за 2000/14/EO • Úřad certifikovaný podle směrnice č. 2000/14/EC • Det britiske bemyndigede organ for 2001/14/EF • Engels adviesorgaan voor 2000/14/EG • Ühendkuningriigi teavitatud asutus direktiivi 2000/14/EÜ mõistes • Direktiivien 2000/14/EY mukainen ilmoitettu tarkastuslaitos Isonsa-Britanniassa • Organisme notifié concernant la directive 2000/14/CE • Britische benannte Stelle für 2000/14/EG • Κοινοποιημένος Οργανισμός Ηνωμένου Βασιλείου για 2000/14/ΕΚ • 2000/14/EK – egysvált királyiságbeli bejelentett szervezet • Organismo Notificato in GB per 2000/14/CE • 2000/14/EK AK re gistrētā organizācija • JK notifikuotais istaigos 2000/14/EC • Korp Notifikat tar-Renju Unit ghal 2000/14/KE • Dopuszczona jednostka badawcza w Wielkiej Brytanii wg 2000/14/WE • Entidade notificada no Reino Unido para 2000/14/CE • Organism notifiat în Marea Britanie pentru 2000/14/CE • Notifikovaný orgán Spojeného královstva pre smernicu 2000/14/ES • Britanski prijavljeni organ za 2000/14/ES • Cuerpo notificado en el Reino Unido para 2000/14/CE • Anmälat organ för 2000/14/EG i Storbritannien</p>	<p align="center"><b>Smithco West Inc. 200 West Poplar Avenue Cameron, WI 54822 USA</b></p>
<p>Operator Ear Noise Level • Оператор на нивото на доловим от ухото шум • Hladina hluku v oblasti uší operátora • Støjniveau i førers ørehøjde • Geluidsniveau oor bestuurder • Műratase operátori kőrvas • Melutasa kőyttőjőn korvan kohdalla • Niveau de bruit à hauteur des oreilles de l'opérateur • Schallpegel am Bedienerohr • Επίπεδο θορύβου σε λειτουργία • A kezelő fülénél mért zajszint • Livello di potenza sonora all'orecchio dell'operatore • Trokšņa līmenis pie operatora auss • Dirbančiojo su mašina patiriamas triukšmo lygis • Livell tal-Foss fil-Widna tal-Operator • Dopuszczalny poziom hałasu dla operatora • Nivel sonoro nos ouvidos do operador • Nivelul zgomotului la urechea operatorului • Hladina hluku pôsobiacna na sluch operátora • Raven hrupa pri ušesu upravljavca • Nivel sonoro en el oído del operador • Ljudnivå vid förarens öra</p>	<p align="center"><b>94dB(A)Lwa (2006/42/EC)</b></p>

<p>Harmonised standards used • Използвани хармонизирани стандарти • Použité harmonizované normy • Brugte harmoniserede standarder • Gebruikte geharmoniseerde standaards • Kasutatud ühlistatud standardid • Käytetyt yhdenmukaistetut standardit • Normes harmonisées utilisées • Angewandte harmonisierte Normen • Εναρμονισμένα πρότυπα που χρησιμοποιήθηκαν • Harmonizált szabványok • Standard armonizzati applicati • Izmantotie saskajotie standarti • Panaudoti suderinti standartai • Standards armonizzati usati • Normy spójne powiązane • Normas harmonizadas usadas • Standardele armonizate utilizate • Použité harmonizované normy • Uporabljeni usklajeni standardi • Estándares armonizados utilizados • Harmoniserade standarder som används</p>	<p>BS EN ISO 12100-1:2003 BS EN ISO 12100-2:2003 BS EN ISO 13857 BS EN 349: 1993+A1:2008</p>
<p>Technical standards and specifications used • Използвани технически стандарти и спецификации • Použité technické normy a špecifikace • Brugte tekniske standarder og specifikationer • Gebruikte technische standaards en specificaties • Kasutatud tehnilised standardid ja spetsifikatsioonid • Käytetyt tekniset standardit ja eritelmät • Spécifications et normes techniques utilisées • Angewandte technische Normen und Spezifikationen • Τεχνικά πρότυπα και προδιαγραφές που χρησιμοποιήθηκαν • Műszaki szabványok és specifikációk • Standard tecnici e specifiche applicati • Izmantotie tehniekie standarti un specificācijas • Panaudoti techniniai standartai ir techninė informacija • Standards u specifikaacijonijiet techni užati • Normy i specyfikacje techniczne powiązane • Normas técnicas e especificações usadas • Standardele tehnice și specificațiile utilizate • Použité technické normy a špecifikácie • Uporabljeni tehnični standardi in specifikacije • Estándares y especificaciones técnicas utilizadas • Tekniska standarder och specifikationer som används</p>	<p>ISO 21299 ISO 5349-1 ISO 5349-2</p>
<p>The place and date of the declaration • Място и дата на декларацията • Místo a datum prohlášení • Sted og dato for erklæringen • Plaats en datum van de verklaring • Deklaratsiooni väljastamise koht ja kuupäev • Vakuutuksen paikka ja päivämäärä • Lieu et date de la déclaration • Ort und Datum der Erklärung • Τόπος και ημερομηνία δήλωσης • A nyilatkozat kelle (hely és idő) • Luogo e data della dichiarazione • Deklarācijas vieta un datums • Deklaracijos vieta ir data • Il-post u d-data tad-dikjarazzjoni • Miejsce i data wystawienia deklaracji • Local e data da declaração • Locul și data declarației • Miesto a dátum vyhlásenia • Kraj in datum izjave • Lugar y fecha de la declaración • Plats och datum för deklarationen</p>	<p>Smithco West Inc. 200 West Poplar Avenue Cameron, WI 54822 USA 10-Dec -09</p>
<p>Signature of the person empowered to draw up the declaration on behalf of the manufacturer, holds the technical documentation and is authorised to compile the technical file, and who is established in the Community. Подпис на човека, умножен да състави декларацията от името на производителя, който поддържа техническата документация и е оторизиран да изготви техническия файл и е регистриран в общността. Podpis osoby oprávněné sestavit prohlášení jménem výrobce, držitel technickou dokumentaci a osoby oprávněné sestavit technické soubory a založené v rámci Evropského společenství. Underskrift af personen, der har fuldmagt til at udarbejde erklæringen på vegne af producenten, der er indehaver af dokumentationen og er bemyndiget til at udarbejde den tekniske journal, og som er baseret i nærområdet. Handtekening van de persoon die bevoegd is de verklaring namens de fabrikant te tekenen, de technischedocumentatie bewaart en bevoegd is om het technische bestand samen te stellen, en die is gevestigd in het Woongebied. Ühenduse registrisse kantud isiku allkirj, kes on volitatud tootja nimel deklaratsiooni koostama, kes omab tehnilisdokumentatsiooni ja kellel on õigus koostada tehniilise toimik. Sen henkilöön allekirjoitus, jolla on valmistajan valtuutus vakuutuksen laadintaan, jolla on hullussaan teknisetasiakirjat, joka on valtuutettu laatimaan tekniset asiakirjat ja joka on sijoittautunut yhteisöön. Signature de la personne habilitée à rédiger la déclaration au nom du fabricant, à détenir la documentation technique, à compiler les fichiers techniques et qui est implantée dans la Communauté. Underschrift der Person, die berechtigt ist, die Erklärung im Namen des Herstellers abzugeben, die die technischen Unterlagen aufbewahrt und berechtigt ist, die technischen Unterlagen zusammenzustellen, und die in der Gemeinschaft niedergelassen ist. Υπογραφή στόμου εξουσιοδοτημένου για την σύνταξη της δήλωσης εκ μέρους του κατασκευαστή, ο οποίος κατέχει την τεχνική έκθεση και έχει την εξουσιοδότηση να ταξινομήσει τον τεχνικό φάκελο και ο οποίος είναι διατεθειμένος στην Κοινότητα. A gyártó nevében meghatalmazott személy, akinek jogában áll módosítania a nyilatkozatot, a műszaki dokumentációt őrzi, engedélyvel rendelkezik a műszaki fájl összeállításához, és aki a közösségben telepedett személy. Firma della persona autorizzata a redigere la dichiarazione a nome del fabbricante, in possesso della documentazione tecnica ed autorizzata a costituire il fascicolo tecnico, che deve essere stabilita nella Comunità. T ás personas paraksts, kura ir pilnvarota deklarācijas sastādīšanai ražotāja vārdā, kurai ir tehniskā dokumentācija, kura ir pilnvarota sagatavot tehnisko reģistru un kura ir apstiprināta Kopienā. Asmuo, kuris yra gana žinomas, kuriam gamintojas suteikė įgaliojimus sudaryti šią deklaraciją, ir kuris įjapasirāšė, turi visą techninę informaciją ir yra įgaliojotas sudaryti techninės informacijos dokumentą. Il-firma tal-persuna awtorizzata li tfassal id-dikjarazzjoni fisem il-fabbrikant, għandha d-dokumentazzjoniteknika u hija awtorizzata li tikkompila l-fajj tekniku u li hija stabbilita fil-Komunità. Podpis osoby upoważnionej do sporządzenia deklaracji w imieniu producenta, przechowującej dokumentację techniczną, upoważnioną do stworzenia dokumentacji technicznej oraz wyznaczonej ds. wspólnotowych. Assinatura da pessoa com poderes para emitir a declaração em nome do fabricante, que possui a documentação técnica, que está autorizada a compilar o processo técnico e que está estabelecida na Comunidade. Semnătura persoanei împuternicite să elaboreze declarația în numele producătorului, care deține documentația tehnică, este autorizată să compileze dosarul tehnic și este stabilită în Comunitate. Podpis osoby poverenej vystavením vyhlásenia v mene výrobcu, ktorá má technickú dokumentáciu a je oprávnená spracovať technické podklady a ktorá je umiestnená v Spoločenstve. Podpis osebe, pooblaščené za izdelavo izjave v imenu proizvajalca, ki ima tehnično dokumentacijo in lahko sestavlja spis tehnične dokumentacije, ter ima sedež v Skupnosti. Firma de la persona responsable de la declaración en nombre del fabricante, que posee la documentación técnica y está autorizada para recopilar el archivo técnico y que está establecido en la Comunidad. Undertecknas av den som bemyndigad att upprätta deklarationen å tillverkarens vägnar, innehar den tekniskadokumentationen och är bemyndigad att sammanställa den tekniska informationen och som är etablerad igemenskapen.</p>	<p>2006/42/EC Annex II 1A: 2 Tim Lansdell Technical Director 19th March 2009 Ransomes Jacobsen Limited West Road, Ransomes Europark, Ipswich, England, IP3 9TT</p>  <p>2006/42/EC Annex II 1A: 10 Dawn Bryngelson Technical Documentation Advisor Smithco Inc. 34 West Avenue Wayne, PA USA 19087-3311 10-Dec -09</p>
<p>Certificate Number • Номер на сертификата • Číslo osvědčení • Certifikatnummer • Certificaatnummer • Sertifikaadi number • Hivjäsytännumero • Numéro de certificat • Bescheinigungsnummer • Αριθμός Πιστοποιητικού • Hitelesítési szám • Numero del certificato • Sertifikata numurs • Sertifikato numeris • Numru tač-Certifikat • Numer certyfikatu • Número do Certificado • Număr certificat • Číslo osvedčenia • Številka certifikata • Número de certificado • Certifikatsnummer</p>	<p>430012009-1</p>



# The Smithco Commercial Products Two-Year Limited Warranty

Smithco, Inc. (Smithco) warrants your 2007 or newer Smithco Commercial Product ("Product") purchased after January 1, 2007, to be free from defects in materials or workmanship for the period of time listed below. Where a warrantable condition exists, Smithco will repair the Product at no cost to you including diagnosis, labor (at the Smithco standard labor rate, subject to the Smithco flat rate schedule), and parts.

**Warranty Duration is:**

- (1) **Two years, 1500 operational hours\* from the date of delivery to the original purchaser or three years from the date of original manufacturer of the product, whichever occurs first. (\*Products equipped with hour meter).**
  
- (2) **Products used in rental situations are covered for 90 days from date of delivery to original user/renter.**

## **Owner Responsibilities:**

As the Product owner, you are responsible for required maintenance and adjustments stated in your Owner's Manual. Failure to perform required maintenance and adjustments can be grounds for disallowing a warranty claim. **You are particularly responsible to train all present and future operators of this product on the safe operation of this product at your location.****Instructions for Obtaining Warranty Service:**

You are responsible for notifying the Authorized Smithco Products Distributor from whom you purchased the Product as soon as you believe a warrantable condition exists and not later than 30 days from discovery of the condition.

If you need help locating an Authorized Smithco Distributor, or if you have questions regarding your warranty rights or responsibilities, you may contact us at:

Smithco Product Support Department  
Highway 55 @ Poplar St.  
Cameron, Wisconsin 54822

Telephone: 715-458-4192

E-Mail: [ProductSupport@Smithco.com](mailto:ProductSupport@Smithco.com)

## **Maintenance Parts:**

Parts scheduled for replacement as required maintenance ("Maintenance Parts"), are warranted for the period of time up to the scheduled replacement time for that part. **Items/Conditions Not Covered:**

Not all product failures or malfunctions that occur during the warranty period are defects in materials or workmanship. The items/conditions listed below are not covered by this warranty:

[\* File contains invalid data | In-line.JPG \*] Product failures which result from the use of non-Smithco replacement parts, or from installation and use of add-on, modified, or unapproved accessories are not covered.

Product failures which result from failure to perform required maintenance and/or adjustments are not covered.

Product failures that result from operating the Product in an abusive, negligent or reckless manner are not covered.

This warranty does not apply to parts subject to consumption through use, unless found to be defective. Examples of parts which are consumed, or used up, during normal Product operation include, but are not limited to: blades, tines, teeth, scarifiers, rakes, plates, wear plates, castor wheels, tires, batteries, filters, belts, nozzles, etc.

This warranty does not apply to failures caused by out-side influence. Items considered to be outside influence include, but are not limited to, weather, storage practices, contamination, use of unapproved coolants, lubricants, additives, or chemicals, etc.

This warranty does not apply to normal "wear and tear" items. Normal "Wear and Tear" includes, but is not limited to, damage to seats due to wear or abrasion, worn painted surfaces, scratched decals or windows, etc.

Smithco may require the return of failed parts or components in order to determine the validity of any warranty claim.

Smithco will not be obligated to replace components of other manufacturers if inspection by the original component manufacturer indicates that failure was due to normal wear and tear, expected consumption through use or improper care or service.

**Other Legal Disclaimers:**

The above remedy for product defects through repair or replacement by an authorized Smithco distributor or dealer is the purchaser's sole remedy for any defect. This warranty gives you specific legal rights, and you may also have other rights which vary from state to state.

**THERE ARE NO OTHER EXPRESS WARRANTIES OTHER THAN THOSE SET FORTH ABOVE. ALL IMPLIED WARRANTIES OF MERCHANTABILITY AND FITNESS FOR USE ARE LIMITED TO THE DURATION OF THE LIMITED WARRANTIES CONTAINED HEREIN.**

Some states may not allow limitations on how long an implied warranty lasts, so the above limitation may not apply to you.

**THE SMITHCO COMPANY IS NOT LIABLE FOR INDIRECT, INCIDENTAL OR CONSEQUENTIAL DAMAGES IN CONNECTION WITH THE USE OF THE PRODUCT, INCLUDING ANY COST OR EXPENSE OF PROVIDING A SUBSTITUTE PRODUCT OR SERVICE DURING PERIODS OF MALFUNCTION OR NON-USE.**

Some states may not allow the exclusion of indirect, incidental or consequential damages, so the above exclusion may not apply to you.

**Smithco neither assumes, nor authorizes any person to assume for it, any other liability in connection with the sale or use of this product.**

**SMITHCO, INC.**

**Wayne, PA 19087**

